

Facility & Campus Sign Catalog



Contents

THE STANDARD OF SIGNAGE

Purpose	4
Procedure	4
Guidelines	5

INTERIOR

Facility Sign Family 6

- Sign Type Overview
- Approved Sign Symbols
- Standard Room Sign
- Small Room Sign
- Office Signs
- Restroom Signs
- Restroom Signs w/ Additional Text
- Stair Signs
- Stair Floor ID
- Letter Info Sign
- Large Info Sign
- Small Info Sign
- Exit Sign
- Stair ID w/ Egress Info
- Flag Sign w/ Symbol
- Flag Sign w/ Text
- Flag Sign / Specialty
- Ceiling-mount Flag

Wayfinding 25

- Facility Directory
- Elevator Directory
- Floor Number
- Landmark Map
- PATH Map
- PATH Flag
- PATH Directional
- Wall Directional
- Entry Directional
- Overhead Directional
- Elevator ID

- Teardrop ID
- Destination Display
- Department Sign (OCH)
- Department Sign (COM)
- Check Out Directional

OU Health Wayfinding 42

- Square ID
- Comprehensive Facility Directory (Large)
- Comprehensive Facility Directory (Small)
- Facility Directory
- Elevator Cab Directory
- Elevator & Floor ID
- Overhead Directional
- Gateway
- Destination Overhead
- Wall Directional w/ Map
- Wall Directional

Informational 57

- Snap Frames
- Policies, Disclosures & Legal
- Access Support
- Hanging Labels
- Magnetic or Printed Labels
- Slider (In Use / Vacant)
- Name Plates
- Office Spinner
- Wheelchair Signs
- Infection Control Kiosk
- Receiving & Delivery
- Hydration Station
- Charging Station
- Magnet Clips (Pack of 10)
- Coat Hooks

Safety 73

- Graphic Safety
- Text Only Safety
- Instructional Support
- Emergency Exit - Vinyl Bands
- Authorized Personnel Only - Vinyl Bands
- Automatic Door - Vinyl Bands

Temporary Signs 80

- Print & Laminate
- Acrylic Stands
- Large Sign Stands
- Snap Frame Stands
- Stanchion w/ Sign Topper

Donor Signs 86

- Room Sign Topper
- Room Sign Topper (OCH)
- Room Donor (w/o Room Sign)
- Donor Story Panel
- Dimensional Lettering
- Building Donor Wall
- Exterior Sculpture Plaque
- Exterior Dimensional Lettering
- Exterior Donor Space

EXTERIOR

Parking & Valet 96

- Valet Podium Magnets
- Trailblazer
- Water-base Sign Holder
- Reserved Parking
- Roll 'n Pole
- No Smoking Stakes

THE STANDARD OF SIGNAGE

To provide high-quality signage solutions, UHAT and OU Health have developed a comprehensive standard signage catalog. This catalog includes signage for inpatient hospital spaces, as well as clinical and professional spaces, ensuring consistency and clear communication across all areas. We are committed to upholding industry standards and requirements, striving for excellence in every project. Our signs are designed to be visually appealing, durable, and functional.

Purpose

The purpose of the signage and graphic catalog for UHAT and OU Health is to consolidate the design, fabrication, and installation of signage throughout the facilities. From the first call through the installation, we are with you every step of the way.

This is intended to meet the needs of the facilities while maintaining overall design cohesion throughout the campus. Adherence to the standard of this document and UHAT/OU Health policies and procedures for control of campus signage will ensure consistency throughout. This document will be the primary reference for those ordering, producing, and implementing the facilities' signage and graphics program. Signage addressed in this document includes all exterior and interior directional, identification, and informational, regulatory signs for guests, patients, employees and other tenants. This document is meant to cover all of UHAT and OU Health-owned, leased, or managed facilities.

Procedure

All departments and associates should contact their Authorized Requester (AR) assigned to the facility or project for any and all sign requests. For facilities that are leased and/or managed by OU Health, sign requests should be handled through the Space and Lease Program Manager. In addition to the rules and regulations noted in this document, the following will also apply:

In the event that a permanent sign cannot be procured in time, all temporary signs must mimic the new sign standards as noted in this document. This includes the sign's look, feel, font, graphics, color, etc. All temporary signs should be coordinated through the facility signage manager.

Guidelines

DOS & DON'TS

- Don't post a sign if the same information could be communicated in more efficient or friendly way.
- Try to use existing signage or wayfinding tools to support a potential need before requesting more signage.
- There should never be any paper signs posted in, around or throughout the facilities, either in associate areas or patient care areas. This includes any 8.5x11 computer print-outs, temporary postings, event advertisements, etc. In the event that a paper sign is found, it will be asked to be removed and disposed of immediately.
- Report signs that don't make sense. If you see a duplicate sign or a sign with out-of-date info, please report the sign to an Authorized Requester(AR) for the sign to be corrected or removed.
- Don't use tape, stickers, adhesive materials, or permanent markers on any new or existing sign. These can and will damage the face of the sign. If a sign becomes obsolete in messaging or functionality, please report the sign so the sign can be properly remove or updated.

SUPPORTING POLICIES OR TOOLS

ADA	Americans with Disabilities Act
ANSI	American National Standards Institute
ASTM	American Society for Testing and Materials
CABO	Council of American Building Officials
CSI	Construction Specification Institute
IBC	International Building Code
LSC	Life Safety Code (written by NFPA)
NEC	National Electrical Code (written by NFPA)
NFPA	National Fire Protection Association
SBCCI	Standard Building Code
UBC	Uniform Building Code

Facility Sign Family

- Standard Room Sign
- Small Room Sign
- Office Signs
- Restroom Signs
- Stair Signs
- Stair Floor ID
- Letter Info Sign
- Large Info Sign
- Small Info Sign
- Exit Sign
- Stair ID & Info
- Flag w/ Symbols
- Flag w/ Text
- Flag Sign / Specialty
- Ceiling-mount Flag



Sign Type Overview

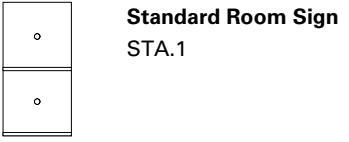

Standard Room Sign
STA.1



Small Room Sign
STA.3



Office Signs
STB.1
STB.1.A
STB.1.B
STB.1.C

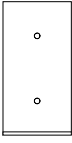

Restroom Signs
STC.1 STC.7
STC.2 STC.8
STC.3 STC.9
STC.4 STC.10
STC.5 STC.11
STC.6 STC.12

**W/ Additional
Line of Text**
STC.#.A



Stair Signs
STD.1.A
STD.1.B

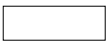

Stair Floor ID
STD.2

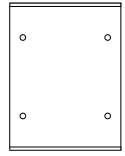

Letter Info Signs
STD.3

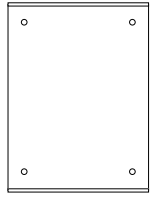

Large Info Signs
STD.4



Small Info Signs
STD.5
STD.6



Flag Signs
STF.1 STF.5
STF.2 STF.6
STF.3 STF.7
STF.4

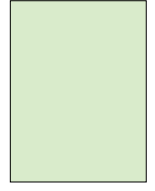

Stair ID & Info
STD.9



Ceiling-Mount Flag Sign
CM.1

Standard Room Sign

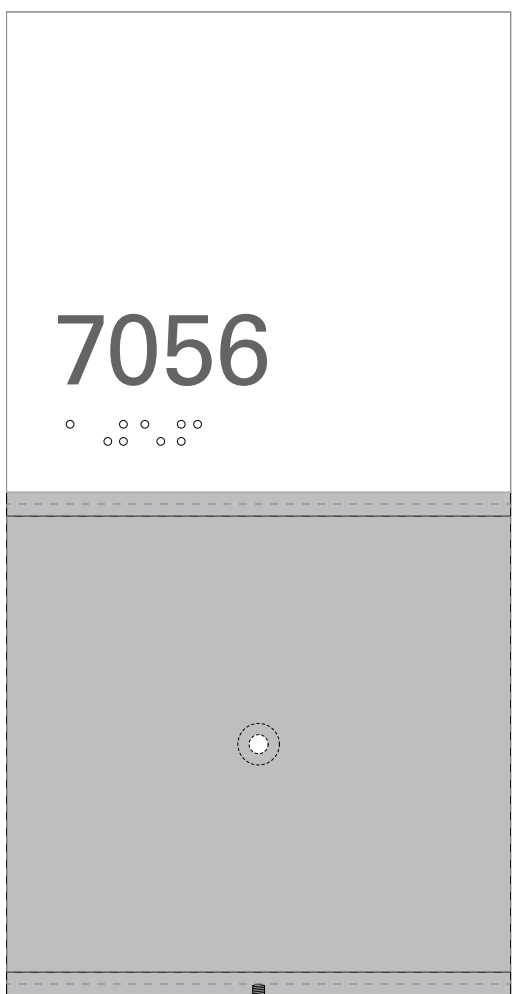
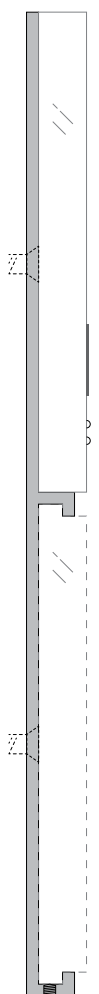

PROFILE

**Standard Room Sign
STA.1**

Extrusion:
10-1/4" x 1/2" x 5-1/4"
Apply 3M 4016 VHB on back
(2 strips, horizontally across top and bottom)

Countersunk Holes: x2
Fits #10 Bulge Head Drywall Screw

Set Screw: x1
Match Existing. Uses 1/16" Hex Head Screwdriver

FOOTPRINT

Acrylic:
Top: 5-1/4" x 5", Apply 3M 467 MP (full back)
Bottom: 5-1/4" x 5" (w/ top & bottom notch)

Message:
Room Number, Braille

Install:
5-1/4" x 10-1/4" Footprint
2 Screws and/or VHB Foam Tape
UHAT-provided insert
Modesty panel applied if installed on glass.

METALLIC PAPER INSERT (EXAMPLES)

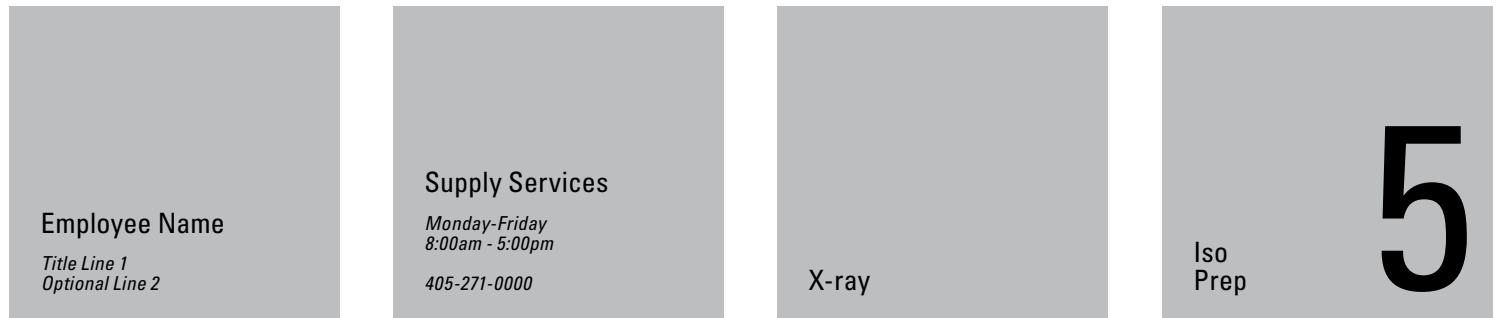

Office Department Info Room Label Exam Room

Small Room Sign

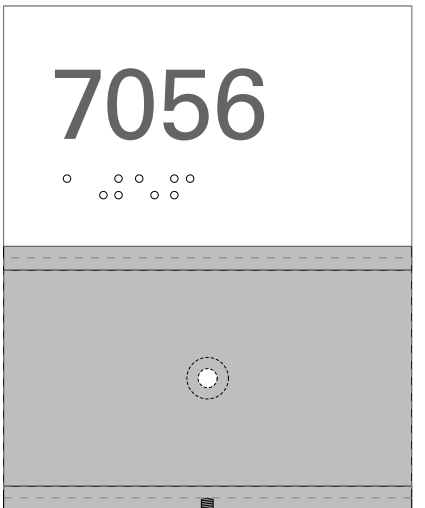
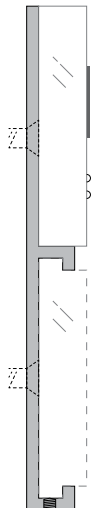

PROFILE

**Small Room Sign
STA.3**

Extrusion:
5-1/4" x 1/2" x 4-1/4"
Apply 3M 4016 VHB on back
(2 strips, horizontally across top and bottom)

Countersunk Holes: x2
Fits #10 Bulge Head Drywall Screw

Set Screw: x1
Match Existing. Uses 1/16" Hex Head Screwdriver

FOOTPRINT

Acrylic:
Top: 4-1/4" x 2-1/2", Apply 3M 467 MP (full back)
Bottom: 4-1/4" x 2-1/2" (w/ top & bottom notch)

Message:
Room Number, Braille

Install:
4-1/4" x 5-1/4" Footprint
2 Screws and/or VHB Foam Tape
UHAT-provided insert
Modesty Panel applied if installed on glass

PAPER INSERT (EXAMPLES)

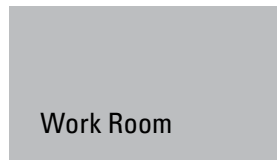

Standard Metallic Labels



Fire Compliance Labels

Office Signs

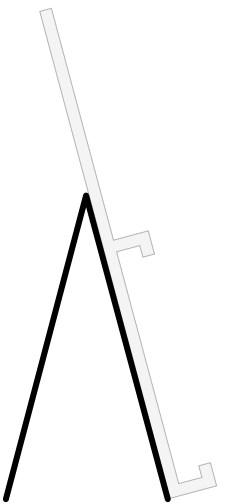
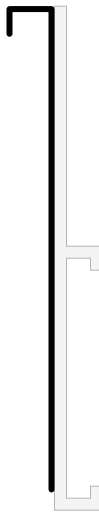
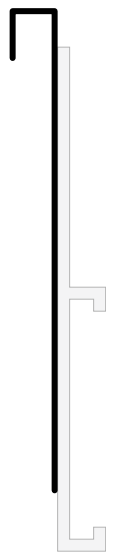
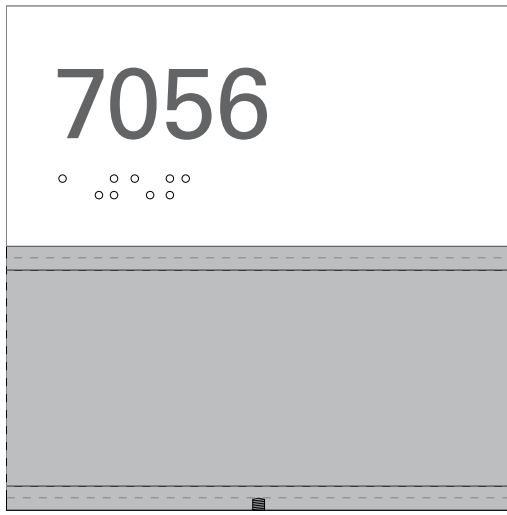

PROFILE

FOOTPRINT

PROFILE

PROFILE

PROFILE

Office Signs STB.1 Fabric Pins - STB.1.A

Extrusion:
5-1/4" x 1/2" x 5-1/4"

Countersunk Holes: x0

Set Screw: x1
Match Existing. Uses 1/16" Hex Head Screwdriver.

Acrylic:
Top: 5-1/4" x 2-1/2, Apply 3M 467 MP (full back)
Bottom: 5-1/4" x 2-1/2" (w/ top & bottom notch)

Message:
Room Number, Braille
Braille Not Required if paired with variant STB.1.C

Install:
5-1/4" x 5-1/4" Footprint
UHAT-provided insert
Optional Fabric Pins

Hanger STB.1.B

Bent Aluminum
16 or 18ga., TBD
Painted

Finished Size:
4-1/4" x 5"

Hanger STB.1.D

Bent Aluminum
16 or 18ga., TBD
Painted

Finished Size:
4-1/4" x 5"

Stand STB.1.C

Bent Aluminum
16 or 18ga., TBD
Painted

Finished Size:
4-1/4" x 3"

Restroom Signs

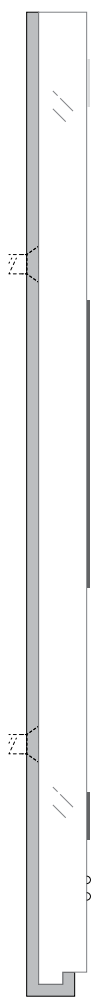

PROFILE



FOOTPRINT

- Restroom Signs**
- | | | | |
|--------------|--------------|--------------|---------------|
| STC.1 | STC.4 | STC.7 | STC.10 |
| STC.2 | STC.5 | STC.8 | STC.11 |
| STC.3 | STC.6 | STC.9 | STC.12 |

Extrusion:
 10-1/4" x 1/2" x 5-1/4"
 Apply 3M 4016 VHB on back
 (3 strips, horizontally across top, middle and bottom)

Countersunk Holes: x2
 Fits #10 Bulge Head Drywall Screw

Acrylic:
 5-1/4" x 10-1/8" (w/ bottom notch)
 Apply 3M 467 MP (full back)

Message:
 Room Number, Symbol, One line of text, Braille

Install:
 5-1/4" x 10-1/4" Footprint
 2 Screws and/or VHB foam tape



STC.1



STC.2



STC.3



STC.4



STC.5



STC.6



STC.7



STC.8



STC.9



STC.10



STC.11



STC.12

Restroom Signs w/ Additional Text

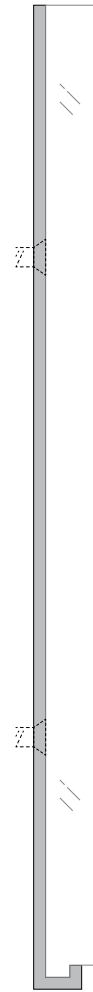

Graphic Area 4-3/4" x 3"
Centered on Acrylic



PROFILE

**Restroom Signs w/ Additional Line of Text
STC.#.A**

Extrusion:
10-1/4" x 1/2" x 5-1/4"
Apply 3M 4016 VHB on back
(3 strips, horizontally across top, middle and bottom)

Countersunk Holes: x2
Fits #10 Bulge Head Drywall Screw

FOOTPRINT

Acrylic:
5-1/4" x 10-1/8" (w/ bottom notch)
Apply 3M 467 MP (full back)

Message:
Two lines of text.
Room Number
Symbols are provided and should never be redrawn or replaced.

Install:
5-1/4" x 10-1/4" Footprint
2 Screws and/or VHB foam tape

Stair Signs

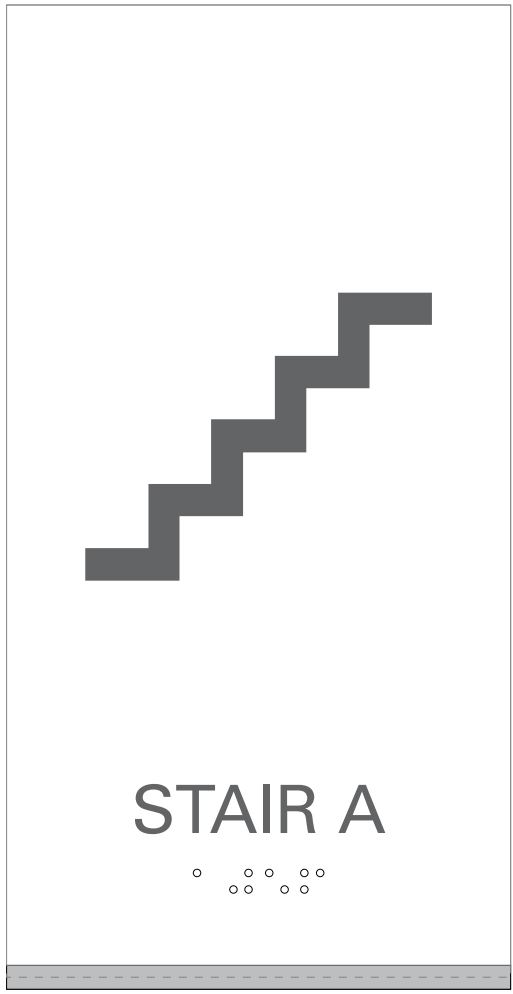
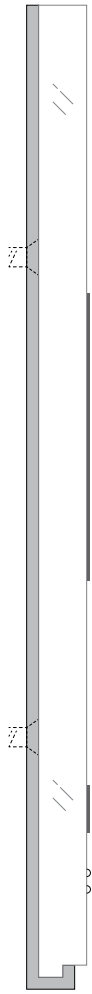

PROFILE

**Stair Signs
STD.1.A**

Extrusion:
 10-1/4" x 1/2" x 5-1/4"
 Apply 3M 4016 VHB on back
 (3 strips, horizontally across top, middle and bottom)

Countersunk Holes: x2
 Fits #10 Bulge Head Drywall Screw

FOOTPRINT

Acrylic:
 5-1/4" x 10-1/8" (w/ bottom notch)
 Apply 3M 467 MP (full back)

Message:
 Symbol, One line of text, Braille

Install:
 5-1/4" x 10-1/4" Footprint
 2 Screws and/or VHB foam tape

**STD.1.B
Stair Signs w/ Exit**

Stair Floor ID



PROFILE

FOOTPRINT

**Stair Floor ID
STD.2**

Acrylic:
9" x 3"
Apply 3M 4016 VHB on back
(2 strips, horizontally across the top and bottom)

Message:
"FLOOR X", Braille

Install:
9" x 3" Footprint
(with tape provided)
See Life Safety Document for install specifications.

Letter Info Sign

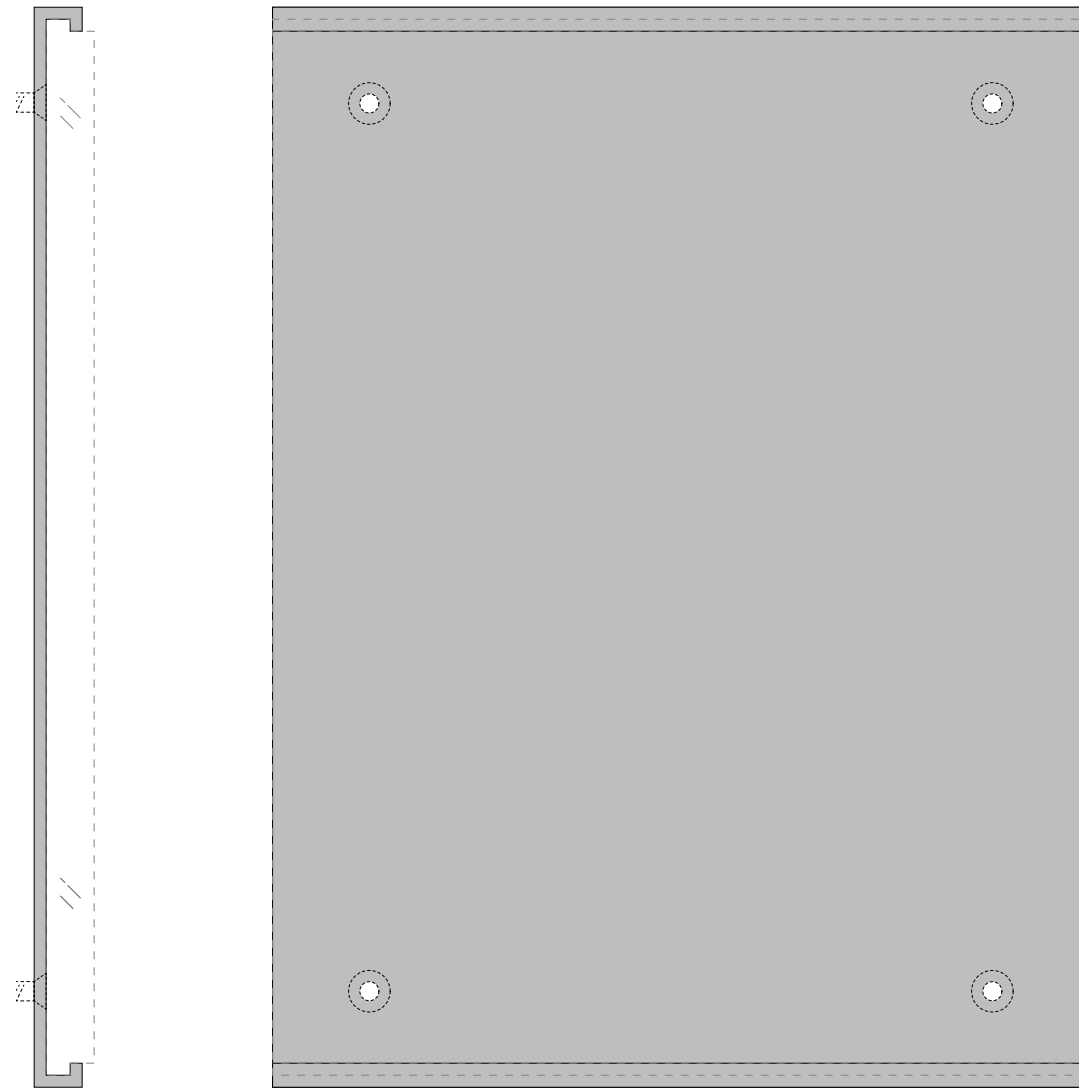

PROFILE

FOOTPRINT

**Letter Info Signs
STD.3**

Extrusion:
11-1/4" x 1/2" x 8-1/2"
Apply 3M 4016 VHB on back
(3 strips, horizontally across top, middle and bottom)

Countersunk Holes: x4
Fits #10 Bulge Head Drywall Screw

Set Screw: x1
Match Existing. Uses 1/16" Hex Head Screwdriver.

Acrylic:
8-1/2" x 11" (w/ top & bottom notch)

Install:
8-1/2" x 11-1/4" Footprint
4 Screws and/or VHB foam tape
UHAT-provided insert

CUSTOM INSERT EXAMPLES FOR STD.3

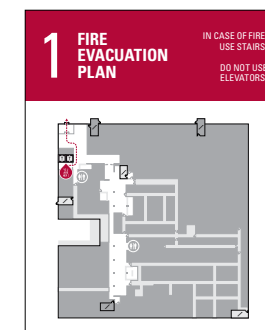

Facility Evacuation/Egress Maps



Custom Messaging for Department Use

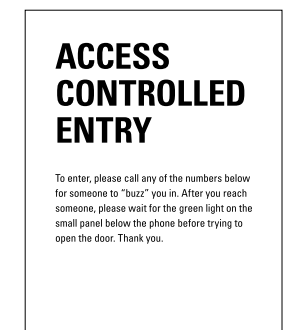
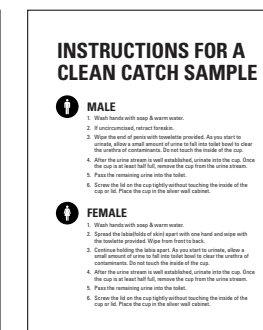

Large Info Sign

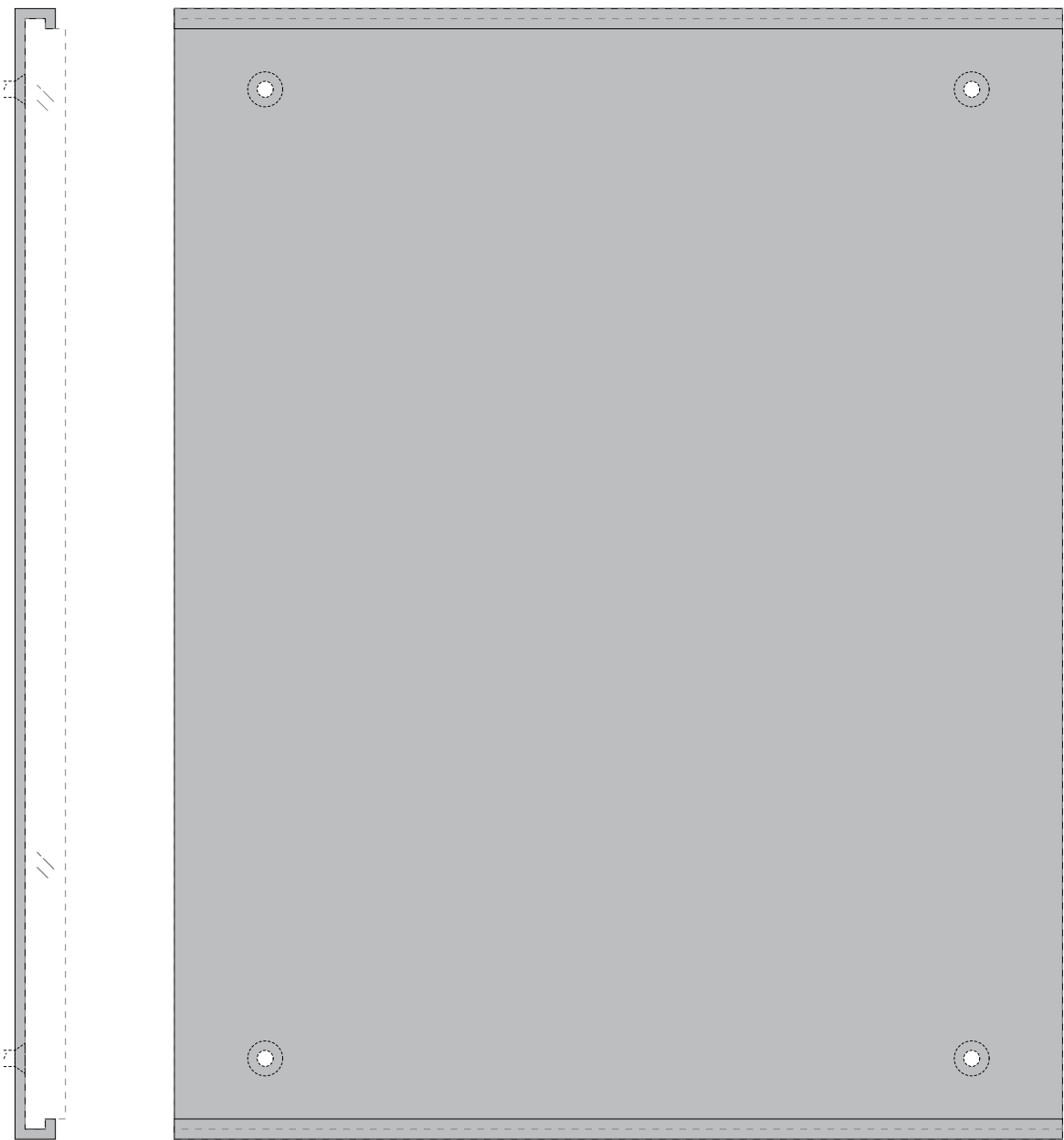

PROFILE FOOTPRINT

Large Info Signs STD.4

Extrusion:
14" x 1/2" x 11"
Apply 3M 4016 VHB on back
(3 strips, horizontally across top, middle and bottom)

Countersunk Holes: x4
Fits #10 Bulge Head Drywall Screw

Set Screw: x1
Match Existing. Uses 1/16" Hex Head Screwdriver.

Acrylic:
11" x 13-3/4" (w/ top & bottom notch)

Install:
14" x 11" Footprint
4 Screws and/or VHB foam tape

Paper Insert:
11 x 13.6875
UHAT-provided insert

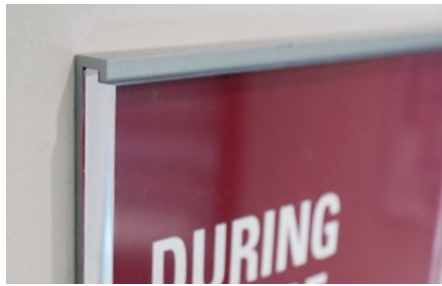

CUSTOM INSERT EXAMPLES FOR STD.4



PATH Maps

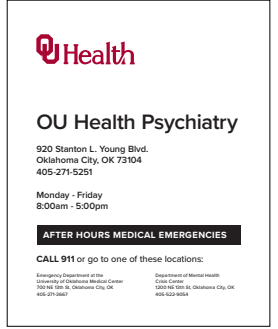

Department Details

Small Info Sign

1/2" One, two or three lines of text, centered vertically and horizontally w/ acrylic face

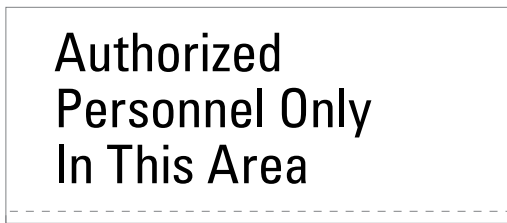

1/4" 1" 1/4" Graphic Area One, two or three lines of text, centered vertically and horizontally w/ graphic

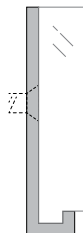

PROFILE

**Small Info Signs
STD.5**

Extrusion:
2-3/8" x 1/2" x 5-1/4"
Apply 3M 4016 VHB on back
(2 strips, horizontally across top and bottom)

Countersunk Holes: x1
Fits #10 Bulge Head Drywall Screw

FOOTPRINT

Acrylic:
5-1/4" x 2-1/4" (w/ bottom notch)
Apply 3M 467 MP (full back)

Message:
UHAT-provided message/artwork
Black vinyl message, second surface
Back-painted white

Install:
5-1/4" x 2-3/8" Footprint
1 Screw and/or VHB foam tape

Exit Sign

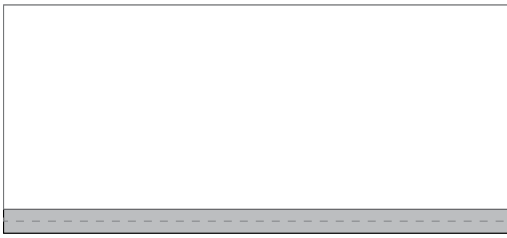
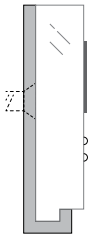

PROFILE

**Exit Signs
STD.6**

Extrusion:
2-3/8" x 1/2" x 5-1/4"
Apply 3M 4016 VHB on back
(2 strips, horizontally across top and bottom)

Countersunk Holes: x1
Fits #10 Bulge Head Drywall Screw

FOOTPRINT

Acrylic:
5-1/4" x 2-1/4" (w/ bottom notch)
Apply 3M 467 MP (full back)

Message:
One line of text. Up to 8 Characters. Braille

Install:
5-1/4" x 2-3/8" Footprint
1 Screw and/or VHB foam tape

Stair ID w/ Egress Info



PROFILE

**Stair ID & Info
STD.9**

1/16" Permalight Backer
13.5" x 18"
Apply 3M 4016 VHB on back
(5 strips, horizontally applied, evenly spaced)

FOOTPRINT

Message:
Customer Provided

Install:
13.5" x 18" Footprint
(with tape provided)
See Life Safety Document for install specifications.

Flag Sign w/ Symbol



STF.1



STF.2



STF.4

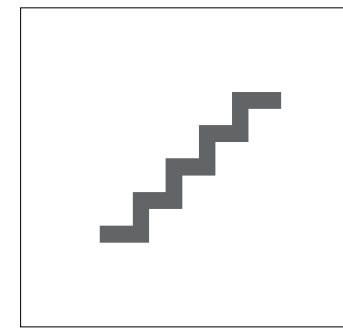

STF.5

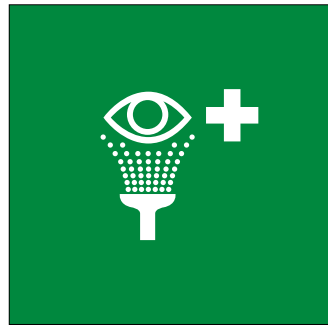

STF.6



Universal Changing Table

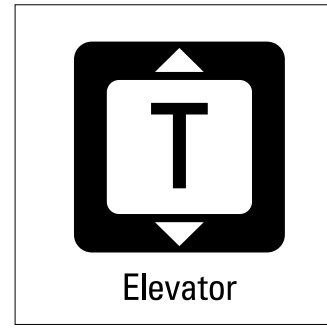

Elevator ID Flag

FOOTPRINT

PROFILE

Flag Sign w/ Symbol
STF.1 STF.4 STF.6
STF.2 STF.5

Extrusion:
 1" x 1/2" x 9" (No Tape)

Countersunk Holes: x2
 Fits #10 Bulge Head Drywall Screw

Tap for Set Screw: x2
 Match Existing. Uses 1/16" Hex Head Screwdriver.

Acrylic:
 (x2) Outer Panels: 9-1/4" x 9"
 (x1) Middle Panel: 9-1/4" x 9"
 Please fully assemble panels into extrusion with set screws secure for delivery.

Message:
Symbol Only, Both Sides
 Symbols are provided and should never be redrawn or replaced.

Install:
 1" x 9" Footprint, 2 Screws



Flag Sign w/ Text

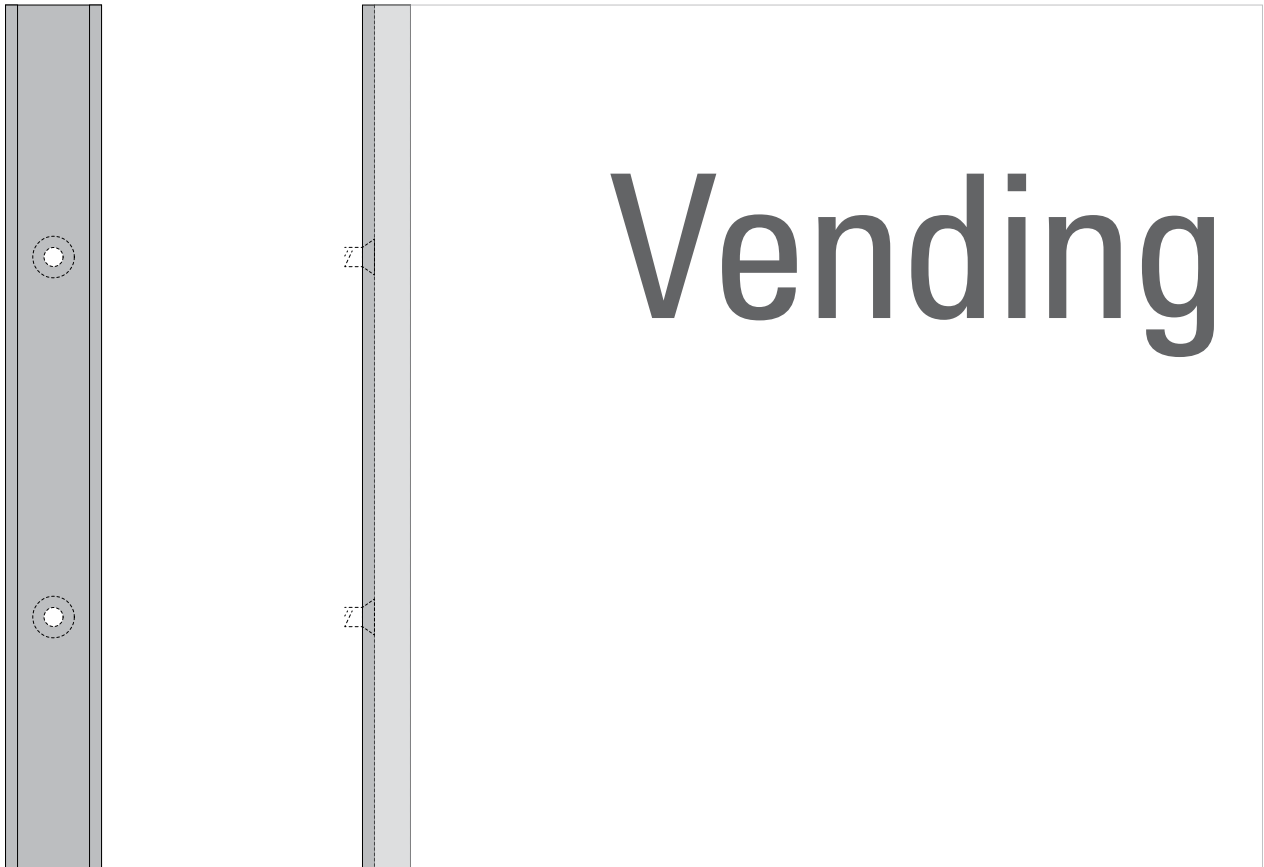

FOOTPRINT PROFILE

Flag Sign w/ Text STF.3

Extrusion:
1" x 1/2" x 9"

Countersunk Holes: x2
Fits #10 Bulge Head Drywall Screw

Tap for Set Screw: x2
Match Existing. Uses 1/16" Hex Head Screwdriver.

Acrylic:
(x2) Outer Panels: 9-1/4" x 9"
(x1) Middle Panel: 9-1/4" x 9"
Note: Please fully assemble panels into extrusion with set screws secure for delivery.

Message:
One, Two or Three lines of text starting from the top line. Justified text opposite install surface. Same messaging on both sides.

Install:
1" x 9" Footprint, 2 Screws

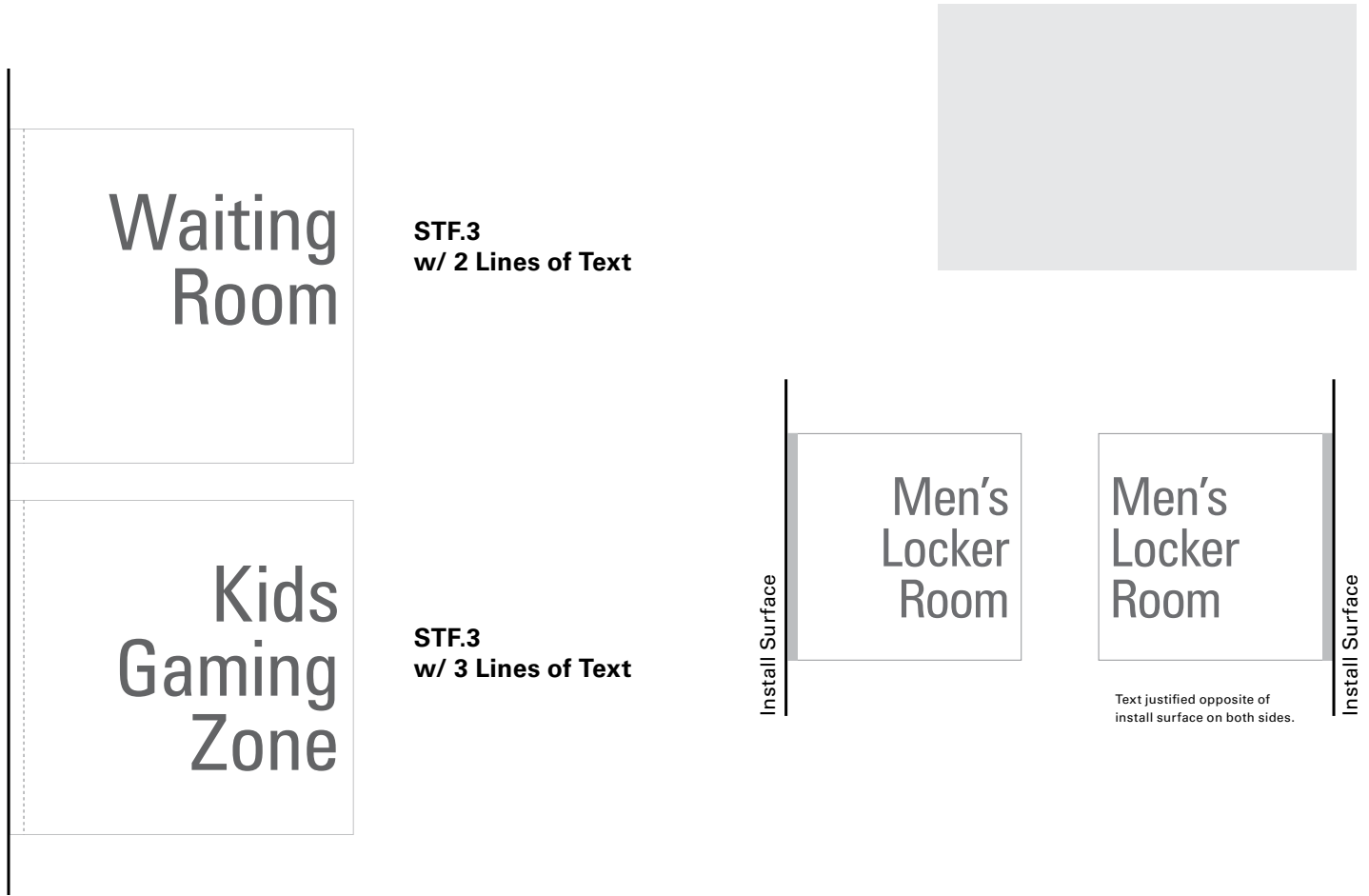

STF.3
w/ 2 Lines of Text

STF.3
w/ 3 Lines of Text

Text justified opposite of install surface on both sides.

Flag Sign / Specialty

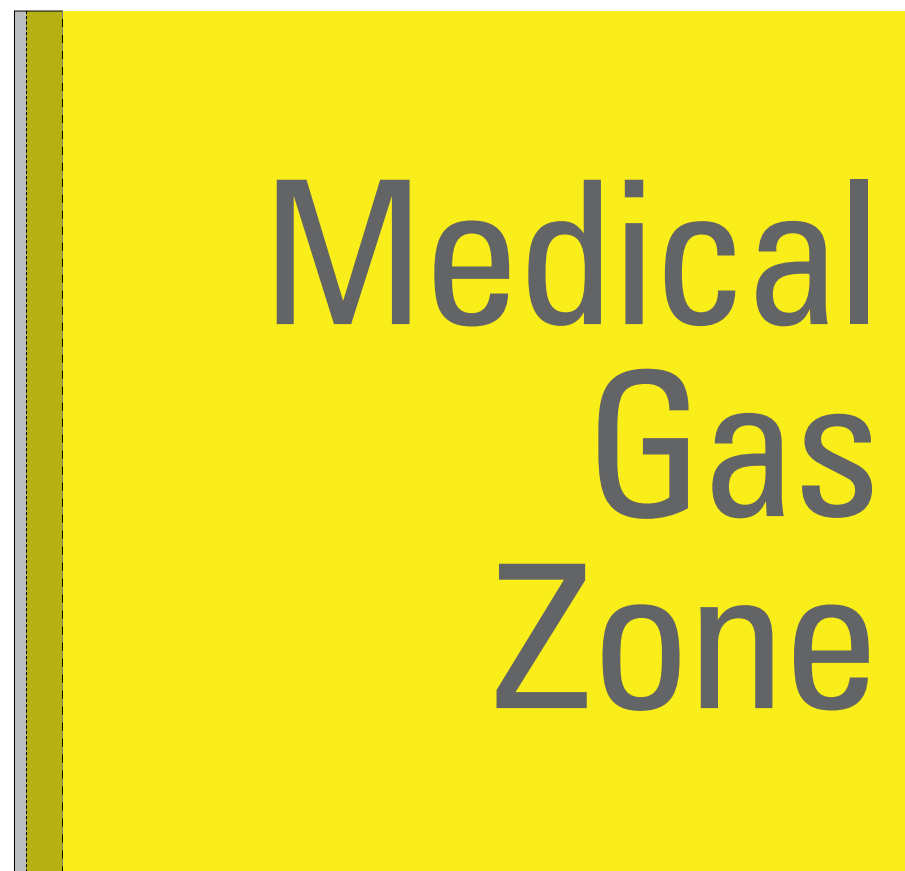

STF.7

Extrusion:
1" x 1/2" x 9"

Countersunk Holes: x2
Fits #10 Bulge Head Drywall Screw

Tap for Set Screw: x2
Match Existing. Uses 1/16" Hex Head Screwdriver.

Acrylic:
(x2) Outer Panels: 9-1/4" x 9"
Back-paint Yellow to match PMS 3955C
(x1) Middle Panel: 9-1/4" x 9"
Note: Please fully assemble panels into extrusion with set screws secure for delivery.

Message:
"Medical Gas Zone"

Install:
1" x 9" Footprint, 2 Screws

Ceiling-mount Flag

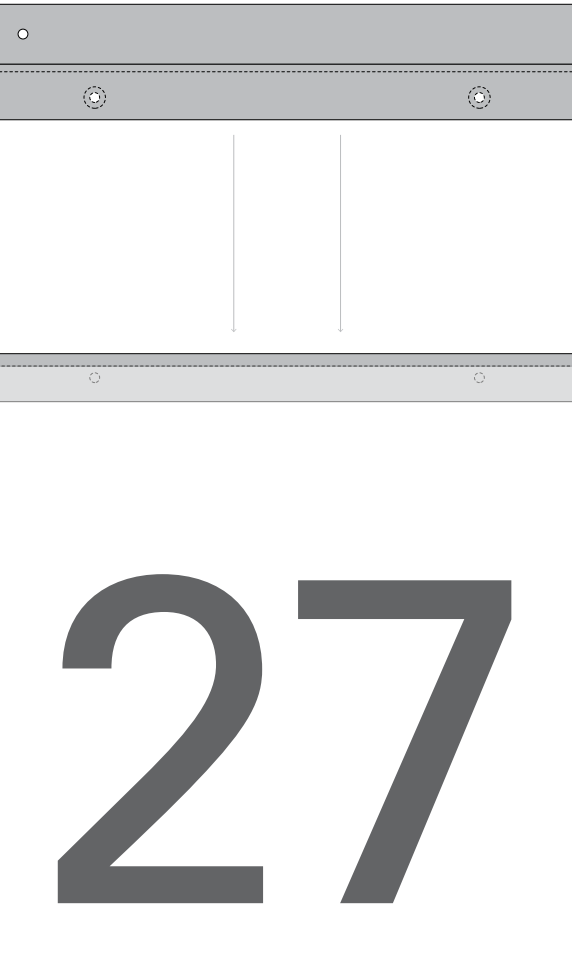
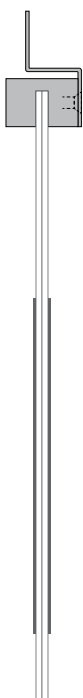

PROFILE

CM.1
Ceiling-Mount Flag

Extrusion:
5/8" x 1/2" x 6"

Countersunk Holes: x2
Fits #4 Flathead Screw

FOOTPRINT

Acrylic:
1/16" P95 Clear Acrylic
Backpainted Natural White (Matthews 42202SP)
6" x 6 -1/32" (x2 Outer Panels)

Message:
1- or 2-digit Number, Double-sided
350pt, Univers 55 Roman
Positioned to center, 3/4" from bottom edge of acrylic

Install:
5/8" x 6" Footprint
(drop-ceiling clip and set screws)

Wayfinding

- Facility Directory
- Elevator Directory
- Floor Number
- Landmark Map
- Path Map
- Path Flag
- Path Directional
- Wall Directional
- Entry Directional
- Overhead Directional
- Check Out Directional
- Teardrop ID
- Destination Display
- Destination/Department Signs
- Elevator ID



Facility Directory

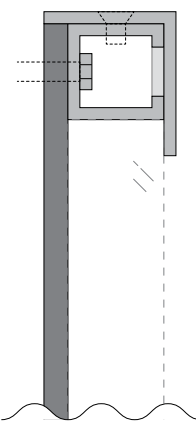

PROFILE

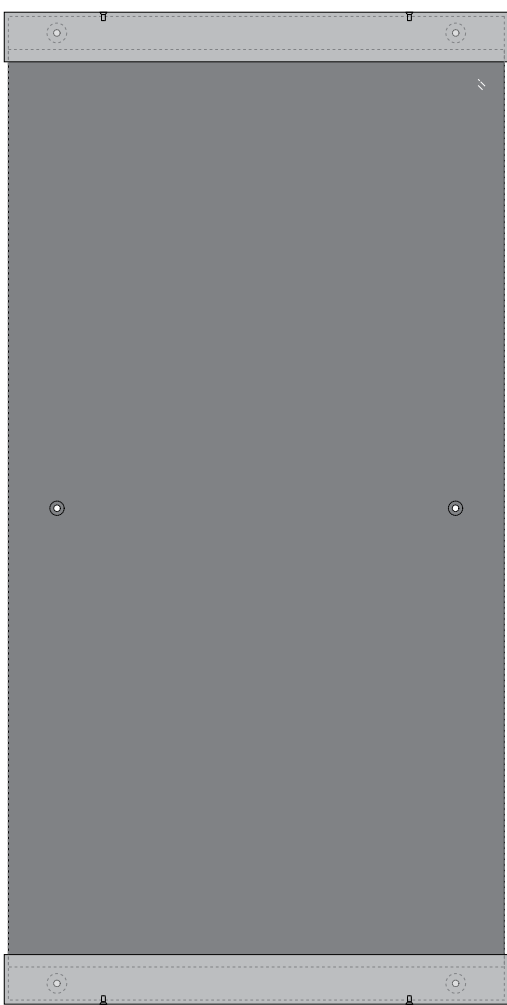

FOOTPRINT

D.1 Facility Directory

- Polystyrene Insert:
UHAT-provided Artwork (15" x TBD)
- 1/4" Acrylic Backer:
15" x (Height of Insert + 2")
Painted Matthews Smelted Grey #18243, Satin
- Aluminum Blocking: x2
14" x 1" Square Tube
w/ relief for access to mounting hardware
Tapped for set screws on top & bottom - Match Existing
- Aluminum Angle Trim Cap:
15.25" x 1.5" x 1.375" (deep)
Including 1/8" Thick Welded End Caps
Painted Matthews Metallic #51695, Satin
Countersunk holes on top and bottom caps
- 1" Clear Acrylic Lens:
15" x (Height of Insert)
Polished Edges
- Holes in Backer:
1/4" Holes in corners to align with holes in Blocking x4
1/4" Countersunk holes(1/2" Screw Head) in vertical middle of backer x2
- Set Screws for Trim Cap: x4
Match Existing to fit 1/8" allen hex head bit and tapped blocking

Install Footprint:
15.25" x (Height of Insert + 2.25")



FACILITY INSERT EXAMPLE

CLINICS	
11	OU Health Administration
10	Jimmy Everest Center
9	Pulmonology & Cystic Fibrosis Gastroenterology
8	Ophthalmology Otolaryngology & Audiology Pediatric Dentistry
7	Urology JEC Pharmacy Neurosurgery Neurology
6	Sooner Pediatrics
5	Pediatric Specialties Adolescent Medicine
4	Diabetes & Endocrinology Universal Changing Table
3	Orthopedic Surgery Radiology Orthopedic Surgery
2	PATH Elevators
	Pharmacy Laboratory
	General & Plastic Surgery Heart Center Atrium Parking / Valet
1	Prenatal Diagnostic Center Parking Garage
B	Orthotics & Prosthetics Medical Records Parking Garage

- Polystyrene Print
- 4" Tall Header w/ Facility Logo
- 3" Wide Column 90 pt Floor Numbers
- Facility departments or other accessible destinations
- IDs or symbols specific to this facility (if applicable)
- IDs or symbols found outside of this facility

Elevator Directory

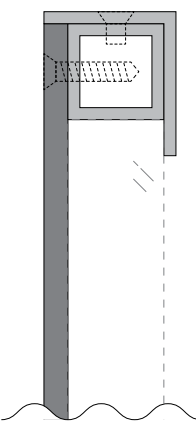

PROFILE



FOOTPRINT

D.2 Elevator Cab Directory

- Polystyrene Insert:
UHAT-provided Artwork (7.5" x TBD)
- 1/4" Acrylic Backer:
7.5" x (Height of Insert + 2")
Painted Matthews Smelted Grey #18243, Satin
Attach backer to Blocking
- Aluminum Blocking: x2
14" x 1" Square Tube
Tapped for set screws on top & bottom block - Match Existing
1/8" Pilot holes to accept screws from backer
- Aluminum Angle Trim Cap:
7.75" x 1.5" x 1.375"(deep)
Including 1/8" Thick Welded End Caps
Painted Matthews Metallic #51695, Satin
Countersunk holes on top and bottom caps
- 1" Clear Acrylic Lens:
7.5" x (Height of Insert)
Polished Edges
- Holes in Backer:
Countersunk holes for #6 x 1" bugle head self-drilling screws, x4
- Set Screws for Trim Cap: x4
Match Existing to fit 1/8" allen hex head bit and tapped blocking

- Install Footprint:
7.75" x (Height of Insert + 2.25")
- Install:
VHB 3M 4016, 4 Horizontal Strips, Evenly Spaced & Silicone

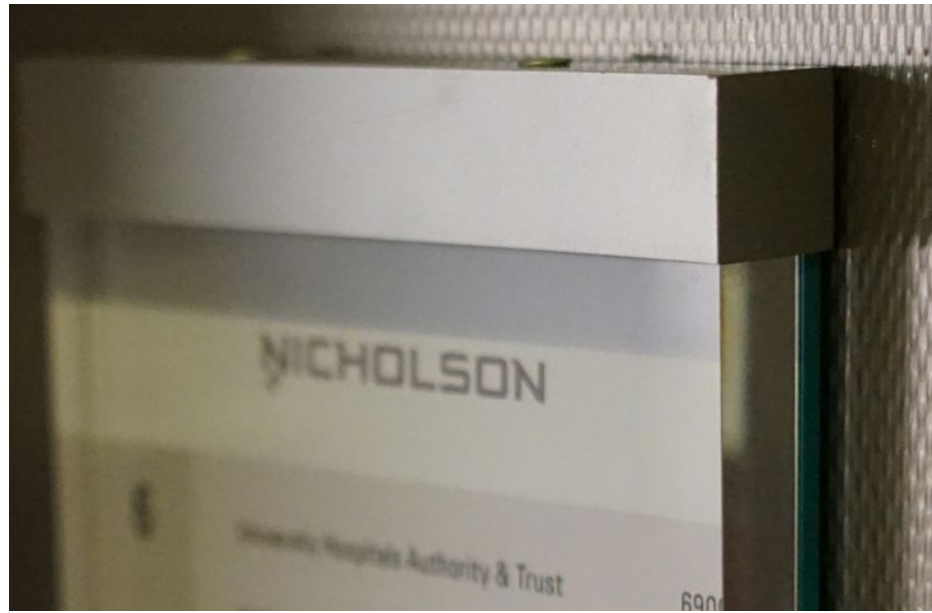
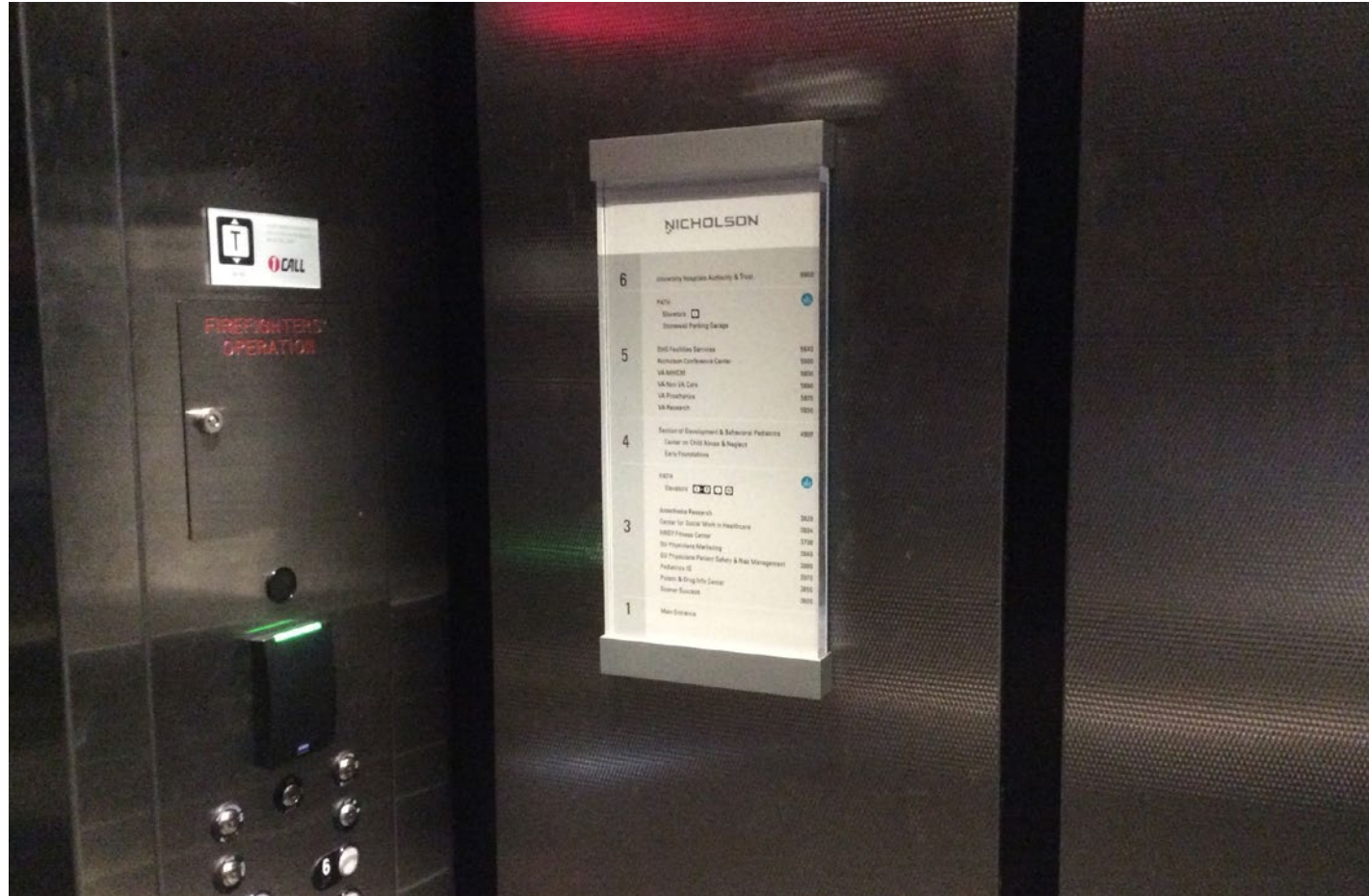

Floor Number

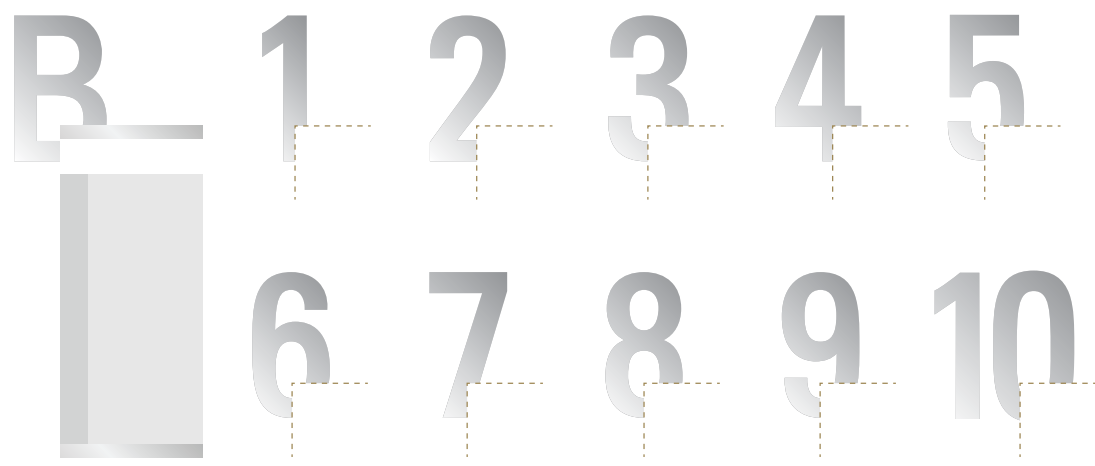

PMS 7711 (shown in OCH)



Satin Aluminum (shown in NIC)



Smelted Gray (shown in ATM)

OVERVIEW

A large number to indicate current floor in tandem with the Facility Directory, so users can quickly know their location within a facility and consider next steps.

INSTALLATION

Tape mount to wall on top-left corner of corresponding Facility Directory.

DIMENSIONS

Optimal size is 24" tall number. Size varies based on available ceiling height.

SPECS

.25" Acrylic
First Surface Paint

FINISH VARIANTS

Finish color varies to match facility aesthetics.

- PMS 7711 (OCH, OCHC)
- Satin Aluminum (OUHP, COM, NIC, GAR)
- Smelted (Matthews, MP18243) (ATM)
- Trendy Gray (Matthews, MR30896)

Landmark Map

Arrow indicates direction you find PATH landmarks on current floor.

Symbol indicates that guest needs to take elevator up/down to continue on the PATH.



Landmark Elevators that can be found on the PATH.

Map Legend: Includes all Facilities, Landmark Elevators and associated Public Parking Garages that are accessible via PATH.

Campus map shows entire PATH and campus roads to provide scale and context

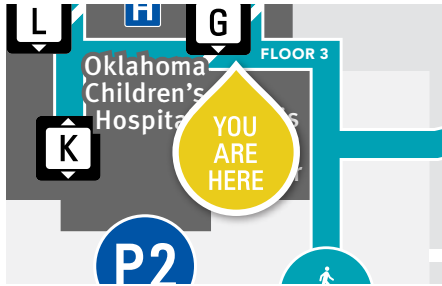

OVERVIEW

A more comprehensive version of a PATH map to help a guest traverse the PATH where it transitions from one floor to another using an elevator. These maps are positioned just outside these landmark elevators on each floor where the transition occurs. The header includes information about how to continue on the PATH and followed by directionals that show the way in which to connect to the other landmark elevators on the PATH. The heads-up map and legend provide more detailed context of facilities, landmarks and parking in association with the highlighted PATH.

INSTALLATION OPTIONS

Wall Mount / Tape

DIMENSIONS

18" x 30"

SPECS

.25" White Foamboard

PATH Map



North

OVERVIEW

A campus map placed under or near PATH Flags along the PATH. This heads-up map includes a yellow "Your Are Here" sticker to help remind guests of their location on the PATH and also give them a more detailed more detailed context of facilities, landmarks and parking in association with the highlighted PATH.

INSTALLATION

11" x 13.6875" Paper Insert for **STD.4**
Uses 1/16" Hex Head Screwdriver

Heads-up Mapping: Orientation of map is installed to match the direction the viewer is when facing the sign. For example, if the viewer will be facing North, install the version of the map that has North at the top. In doing so, everything on the left side of the map is to the left of the viewer.



East



South



West

PATH Flag



PROFILE



ISOMETRIC



FROM ABOVE

OVERVIEW

A two-sided symbol hanging perpendicular to the wall to help pedestrians navigate the PATH. The flags are meant to be seen at a distance and used like bread crumbs along the PATH.

INSTALLATION

4 Screws in Wall Plate
ADA Requires the bottom of sign to be at least 80" from the floor.

Flags are hung in proximity to other flags where at least one other flag can be seen(in both directions) from a position on the PATH.

SPECS

.25" x 10" Acrylic Disk
Painted PMS 7711

.25" Hardware, Text and Graphics
Painted Satin Aluminum



A two-sided symbol hanging perpendicular to ceiling to help pedestrians navigate the PATH. Only use when walls do not allow for clear and consistent placement through a larger space.



A two-sided symbol mounted on a corner in hallways to help pedestrians recognize and make appropriate turns on the PATH.



A one-sided PATH symbol against a wall to help pedestrians navigate the PATH. Used when other PATH Sign variants are not optional.

PATH Directional

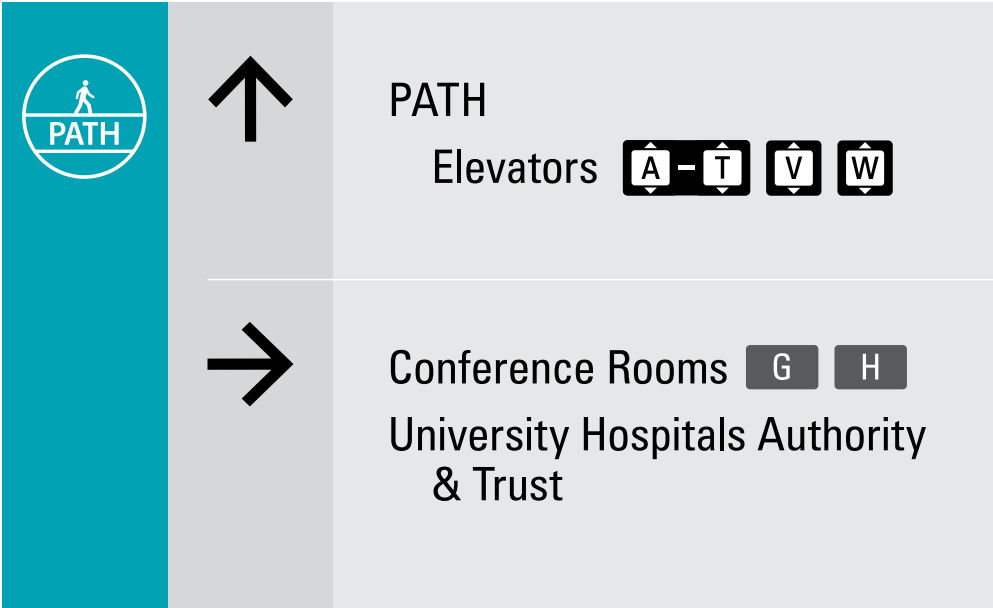

OVERVIEW

Similar to the Wall Directional, this wall-mounted sign has a PATH logo on the left. This directional is placed at PATH intersections to confirm routes. Used in addition to PATH Flags. Used in addition to or in place of Overhead Directionals.

INSTALLATION OPTIONS

Wall Mount / Tape

DIMENSIONS

18" wide x (variable height)

SPECS

.25" Clear Acrylic
Back-printed

RULES

- Directionals on include items on same floor/level.
- Arrows could point to departments, clinics, parking, elevators, amenities, PATH or other facilities.
- Multiple directionals could be used as breadcrumbs to connect guests from one place to another.
- List all applicable items per one arrow type.
- If multiple arrows, separate each section with 2pt white line.
- Verbiage and symbols on the directional should match those on other facility signage and/or wayfinding tools.
- Building names maybe we used, but not in place of Elevator Landmarks. Always include Elevator Landmarks before building name.
- DO NOT USE a down arrow. This can be confusing between wall directionals and overhead directionals.

PREFERRED ARROWS



SECONDARY ARROWS



Wall Directional

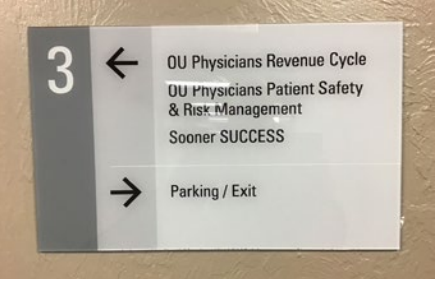
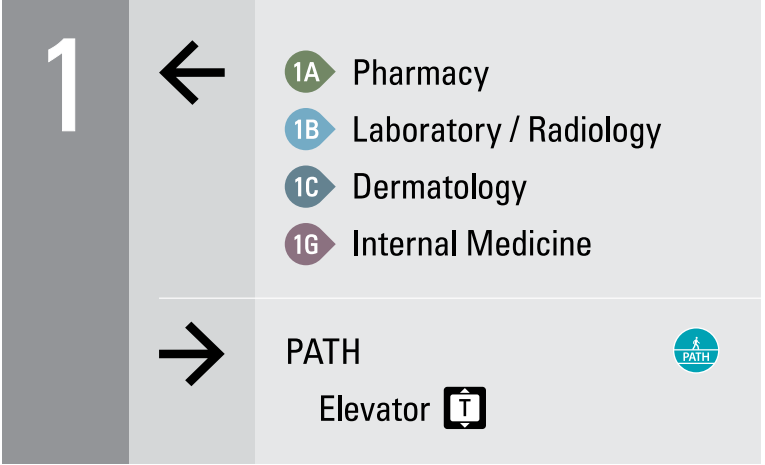

OVERVIEW

A smaller wall-mounted sign at important intersections to confirm routes. Used in addition to or in place of Overhead Directionals.

INSTALLATION OPTIONS

Wall Mount / Tape

DIMENSIONS

18" wide x (variable height)
Sign height determined by amount of content on that floor or overall facility.

SPECS

.25" Clear Acrylic
Back-printed

RULES

- Directionals include items on same floor/level.
- Arrows could point to departments, clinics, parking, elevators, amenities, PATH or other facilities.
- Multiple directionals could be used as breadcrumbs to connect guests from one place to another.
- List all applicable items per one arrow type.
- Verbiage and symbols on the directional should match those on other facility signage and/or wayfinding tools.
- DO NOT USE a down arrow. This can be confusing between wall directionals and overhead directionals.

PREFERRED ARROWS



SECONDARY ARROWS



Entry Directional

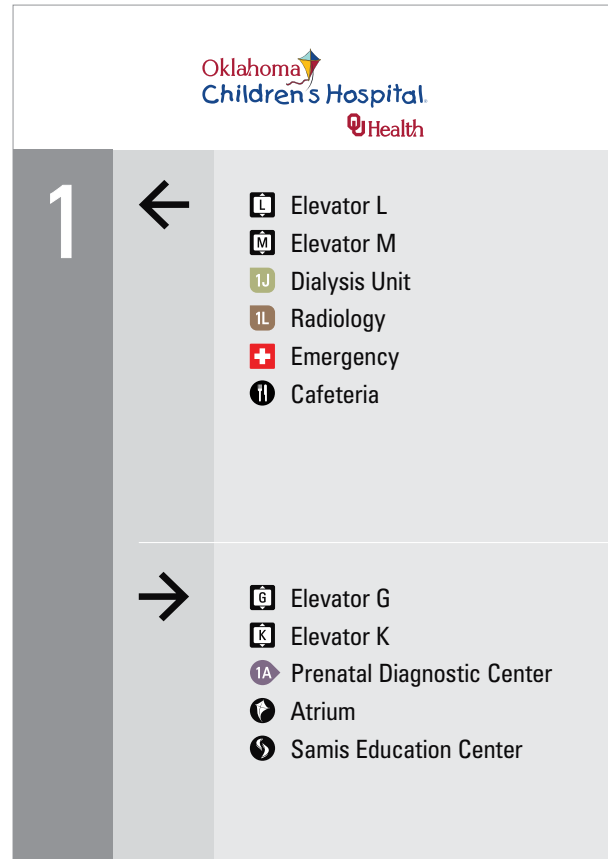

OVERVIEW

A wall-mounted directional in main entrances of facilities and PATH that direct pedestrians to upcoming destinations. This sign type may combine with or take the place of Facility Directories or Overhead Directionals.

INSTALLATION OPTIONS

Wall Mount / Tape

DIMENSIONS

24" wide x (variable height)

SPECS

.25" Clear Acrylic
Back-printed

RULES

- Directionals include items on same floor/level.
- Arrows could point to departments, clinics, parking, elevators, amenities, PATH or other facilities.
- Multiple directionals could be used as breadcrumbs to connect guests from one place to another.
- List all applicable items per one arrow type.
- Verbiage and symbols on the directional should match those on other facility signage and/or wayfinding tools.
- DO NOT USE a down arrow. This can be confusing between wall directionals and overhead directionals.

PREFERRED ARROWS



SECONDARY ARROWS



Overhead Directional

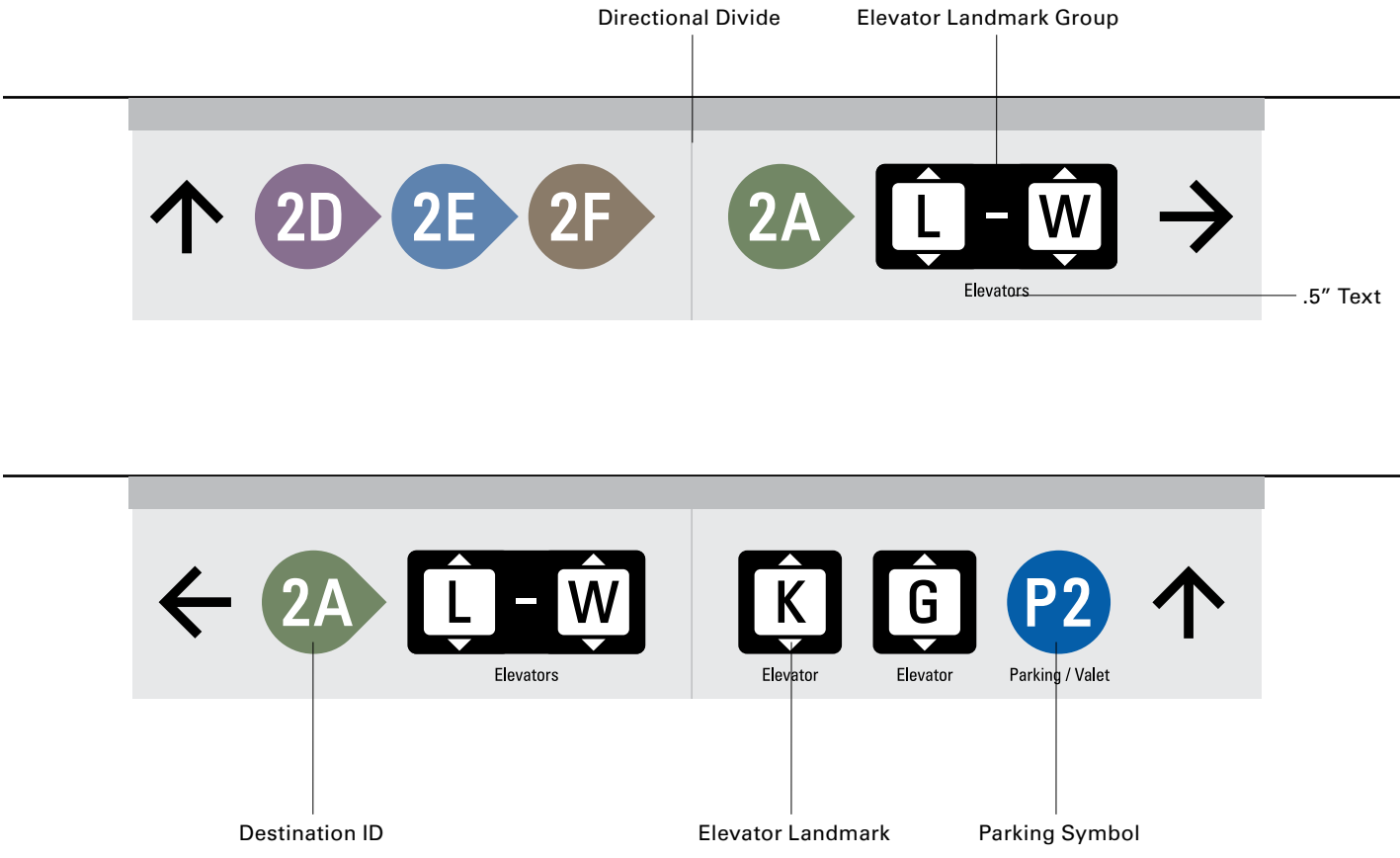

OVERVIEW

Directional signs hanging from ceilings in facilities and on the PATH that direct pedestrians to nearby destinations and landmarks. The messaging is meant to use graphic symbols, with limited text, to help streamline content for quick interpretation regardless of spoken language.

INSTALLATION OPTIONS

- Flush Ceiling Mount
- Wire Suspension
- Wall Mount near ceiling

ADA REQUIREMENTS

The bottom of sign should be at least 80" from the floor.

DIMENSIONS

1.5" x 1.5" Header Bar
 9" Tall Message Area
 10.5" Total Height

WIDTH VARIANTS

A grid of 6.5" blocks to account for the width of the symbols and space between each.

OCHC & OUHP

21.5", 28", 34.5", 41", 47.5", 54", 60.5", 61.5", 67", 73.5", 80", 86.5"

RULES

- Directionals include items/symbols on same floor/level.
- Arrows could point to departments, clinics, parking, elevators, amenities, PATH or other facilities.
- Multiple directionals could be used as breadcrumbs to connect guests from one place to another.
- List all applicable items per one arrow type. Space is limited on each side of the directional, but sometimes the adjacent directionals can assist in sharing content to complete the desired wayfinding message.
- Symbols(and possibly verbiage) on the directional should match those on other facility signage and/or wayfinding tools.
- DO NOT USE a down arrow. This can be confusing between wall directionals and overhead directionals.

PREFERRED ARROWS



SECONDARY ARROWS

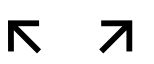

Elevator ID

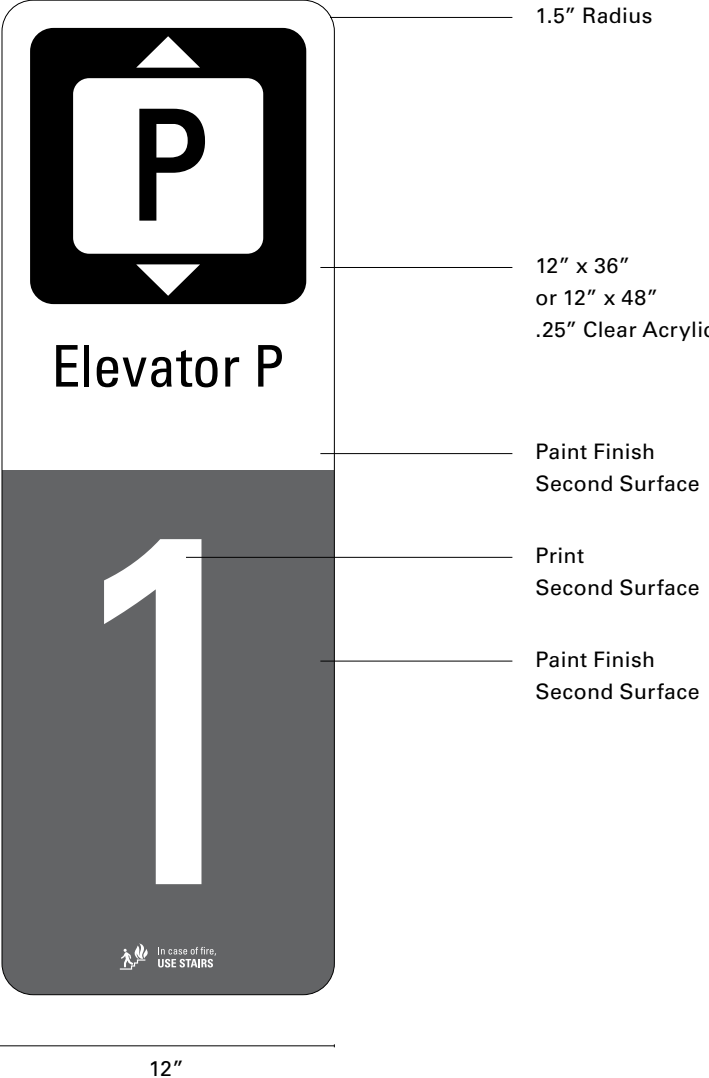
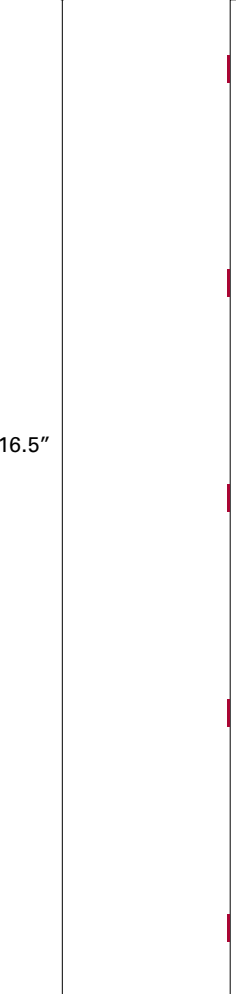

OVERVIEW

Large symbol to identify Elevator Landmarks. Installed near elevator cabs. Multiple signs could be used if number of cabs or space allows.

INSTALLATION

Wall Mount / Tape

DIMENSIONS

12" x 36", 12" x 48"
1.5" radius corners

SPECS

.25" Clear Acrylic
White vinyl graphic with back-paint finish

PAINT FINISH VARIANTS

- Satin Silver
- Smelted (Matthews, MP18243)
- Trendy Gray (Matthews, MR30896)

Teardrop ID

Clinic Destinations (OUHP, OCHC, NIC, OUHTI)

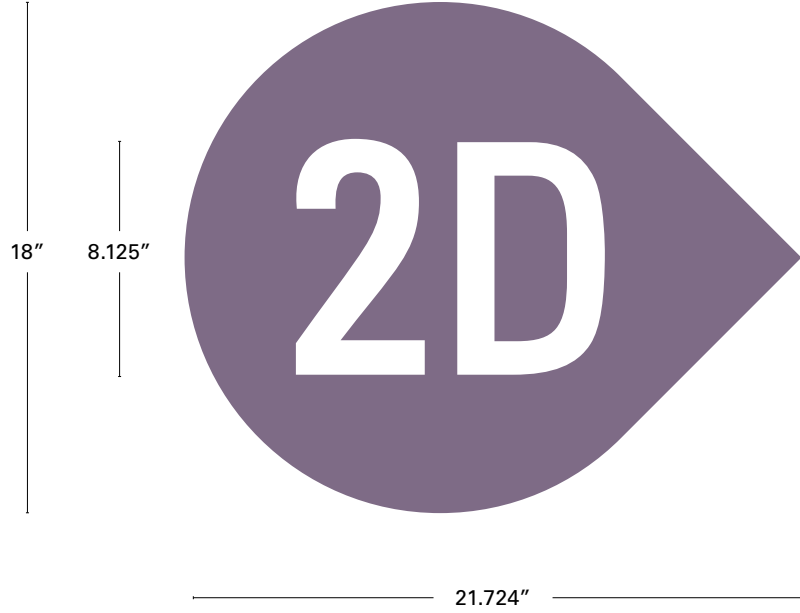

12" variant shown in OUHTI

OVERVIEW

Two-sided signs to indicate clinic destinations. Generally mounted to prominent column or wall adjacent to the clinic reception desk or entrance.

INSTALLATION

Wall Mount / 2 Screws
ADA requires the bottom of sign to be at least 80" from the floor.

DIMENSIONS

18" Tall Cabinet
First Surface Paint (match clinic or facility colors)
12" tall cabinet allowed if ADA requirements can't be met.

.25" Thick Acrylic Text
Back-painted White

Destination Display

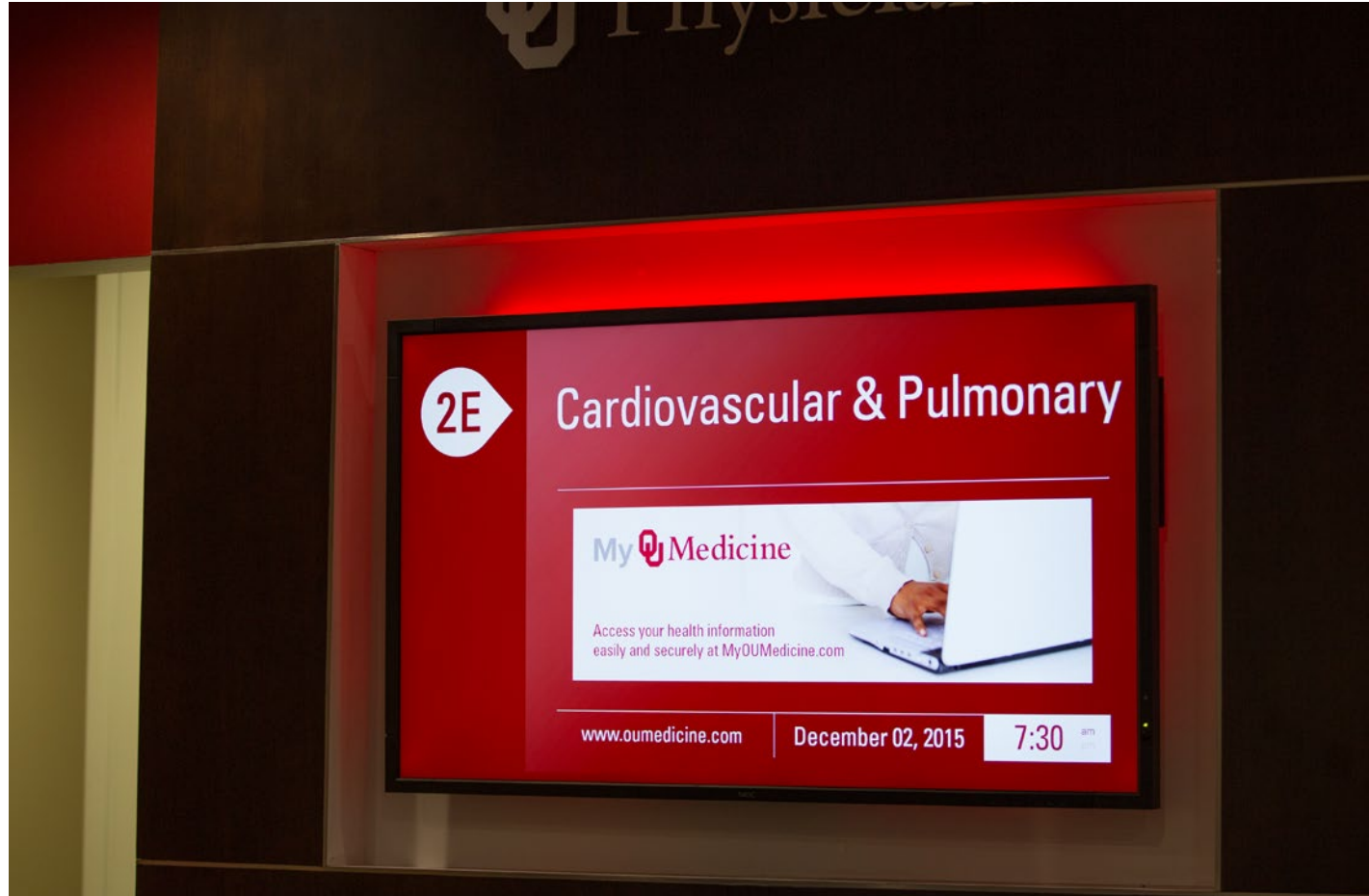
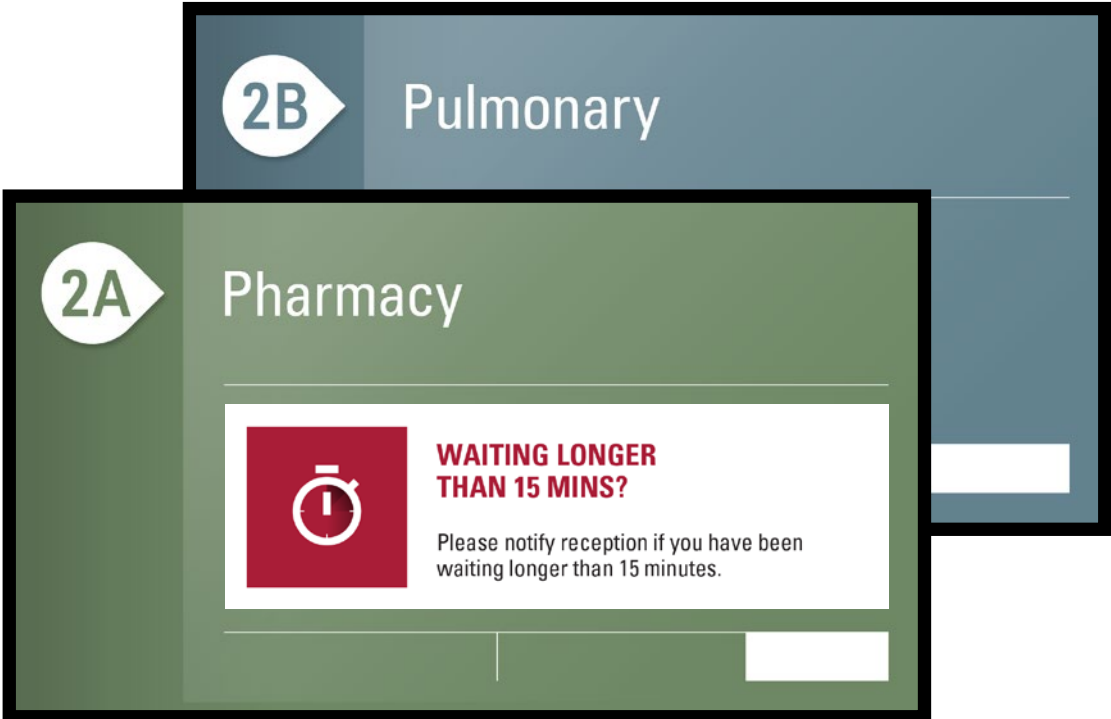

DISPLAYS WITH DOCTOR WAIT TIMES OR INFO



OVERVIEW

A digital display that cycles a library of custom information for that destination, facility or organization. Hardware and graphics provided and managed by UHAT.

MOUNTING OPTIONS

- Enclosure
- Wall Mount

ORIENTATION OPTIONS

- Vertical
- Horizontal

RESOLUTION OPTIONS

- 1920 x 1080
- 1280 x 720

EXAMPLE OF ADDED SPECIAL MESSAGING (1414 X 435)



Department Sign (OCH)



36" x 36"



OVERVIEW
 Oklahoma Children's Hospital has a standard for department signs. This sign type has also been used to identify a secondary space like a conference center or sponsored facility space. A few examples are shown above with one, two and three lines of text.

DIMENSIONS
 Default size: 48" x 36"
 Alternate sizes as space allows: 36" x 36" and 24" x 18"

PRODUCTION SPECS
 1" Radius Corners
 4 or 6 Standoffs 1.5" from edges

 .5" Acrylic
 Back-printed Graphics
 30% White Background Finish

Department Sign (COM)

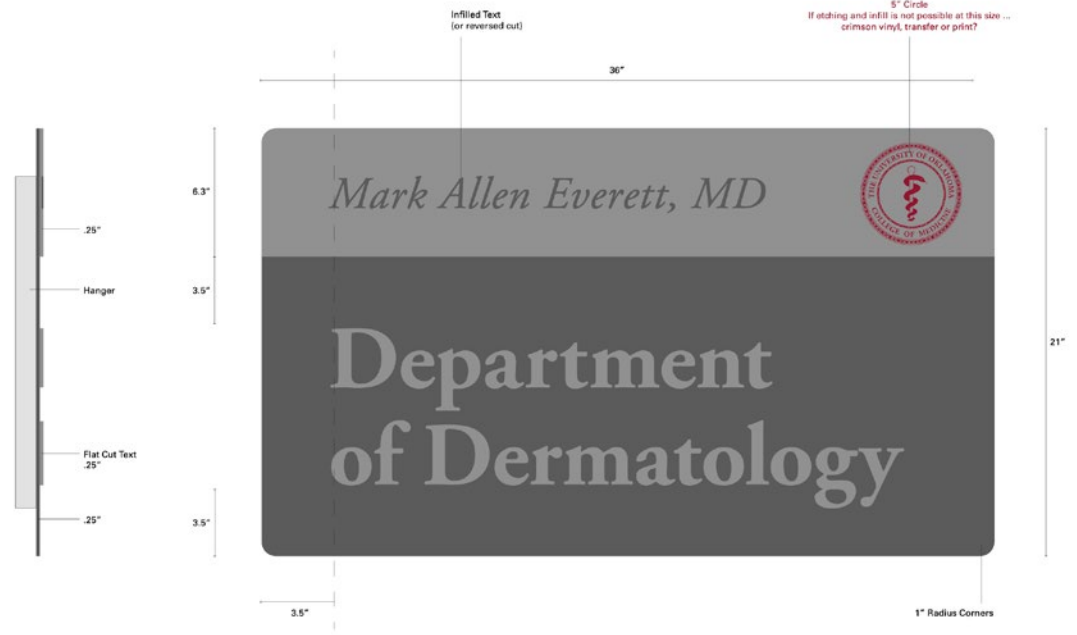

36" x 21"



60" x 30"

OVERVIEW

A standard sign for College of Medicine departments in UHAT-managed facilities.

PRODUCTION SPECS

36" x 21" or 60" x 30" (sized as space allows)
Two Layers of 1/4" Acrylic
First surface printed seal

French Cleat Mount:

2" tubing frame on full perimeter with aluminum angle cleats for a wall mounted installation with 2" float

PAINT FINISHES

- Smelted (Matthews, MP18243)
- Trendy Gray (Matthews, MR30896)

Check Out Directional

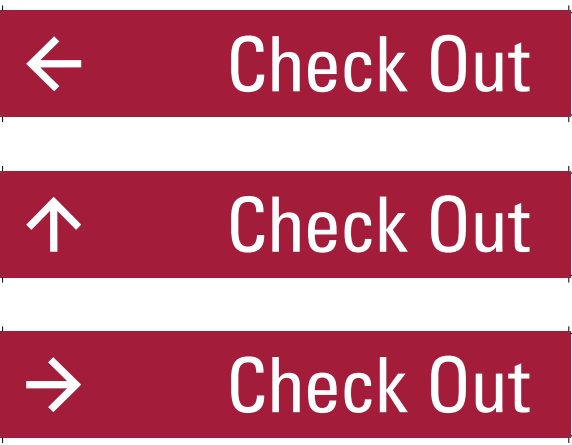
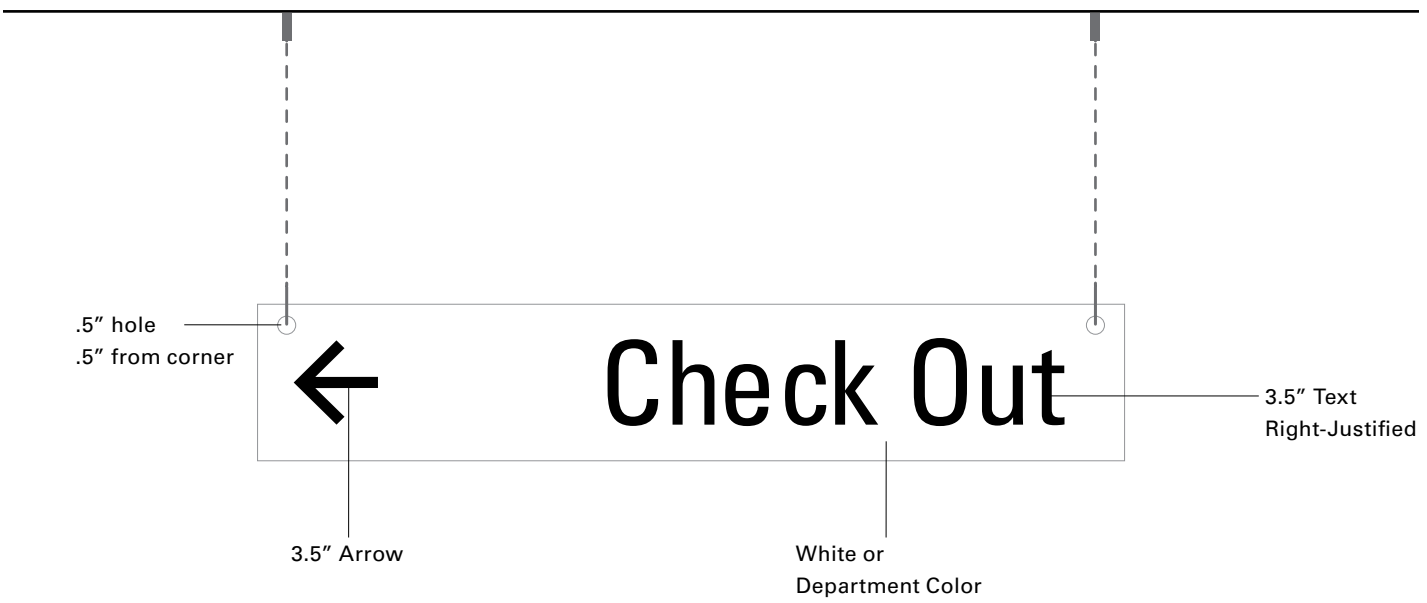

OVERVIEW

Directional signs hanging from ceilings in clinic hallways to help guests find their way back to the clinic reception desk in order to check out after their visit. A generic white acrylic with black messaging is always a clean look, but the sign background could be color coordinated with the facility or clinic to aid the guest in finding the correct check out location.

DIMENSIONS

36" x 6.5"

FINISHING SPECS

1/4" Clear Acrylic
Two .5" holes at the top corners, .5" from corner.

First Surface Lettering: Oracal 73 Dark Grey or White
Second Surface Finish: printed or colored vinyl

RULES

- Directionals include items/symbols on same floor/level.
- Arrows could point to departments, clinics, parking, elevators, amenities, PATH or other facilities.
- Multiple directionals could be used as breadcrumbs to connect guests from one place to another.
- List all applicable items per one arrow type. Space is limited on each side of the directional, but sometimes the adjacent directionals can assist in sharing content to complete the desired wayfinding message.
- Symbols(and possibly verbiage) on the directional should match those on other facility signage and/or wayfinding tools.
- DO NOT USE a down arrow. This can be confusing between wall directionals and overhead directionals.

PREFERRED ARROWS



SECONDARY ARROWS



OU Health Wayfinding

FOR ADULT AMBULATORY FACILITIES

- Square ID
- Comprehensive Facility Directory (Large)
- Comprehensive Facility Directory (Small)
- Facility Directory
- Elevator Cab Directory
- Elevator & Floor ID
- Wall Directional w/ Map
- Wall Directional
- Overhead Directional
- Overhead Destination
- Gateway



The updated hospital wayfinding system has changed to better assist guests and staff on finding their way around our facilities. The chart below is a way to see and learn how the new tower names and the related symbols and landmarks are organized.

FACILITY & LANDMARK NAMING LANDMARK SYMBOLS PARKING ACCESS & SYMBOLS DESTINATION IDS

TOWER A
ENTRANCE A
ELEVATOR A

Formerly known as
NORTH TOWER

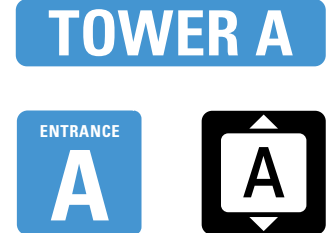

VALET
PICK-UP / DROP-OFF
MAIN LOBBY
CLOSEST TO ADMITTING



TOWER B
ENTRANCE B
ELEVATOR B

Formerly known as
SOUTH TOWER

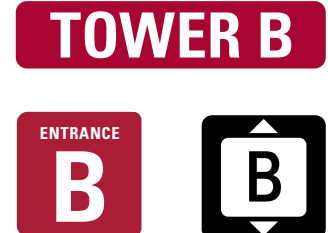

TOWER C
ENTRANCE C
ELEVATOR C

Formerly known as
SOUTH ENTRANCE

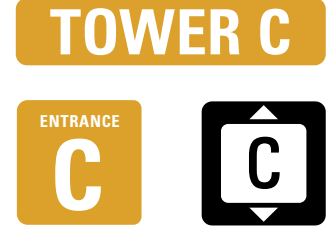

1Y Infusion Services

Concise Department Name
Unique Character per Destination
Floor Number
Tower Color

New facility directories and strategically placed wall directionals now include updated maps to help guests find destinations, but also visually see the relationship of each tower to another.

Floor 1 Map

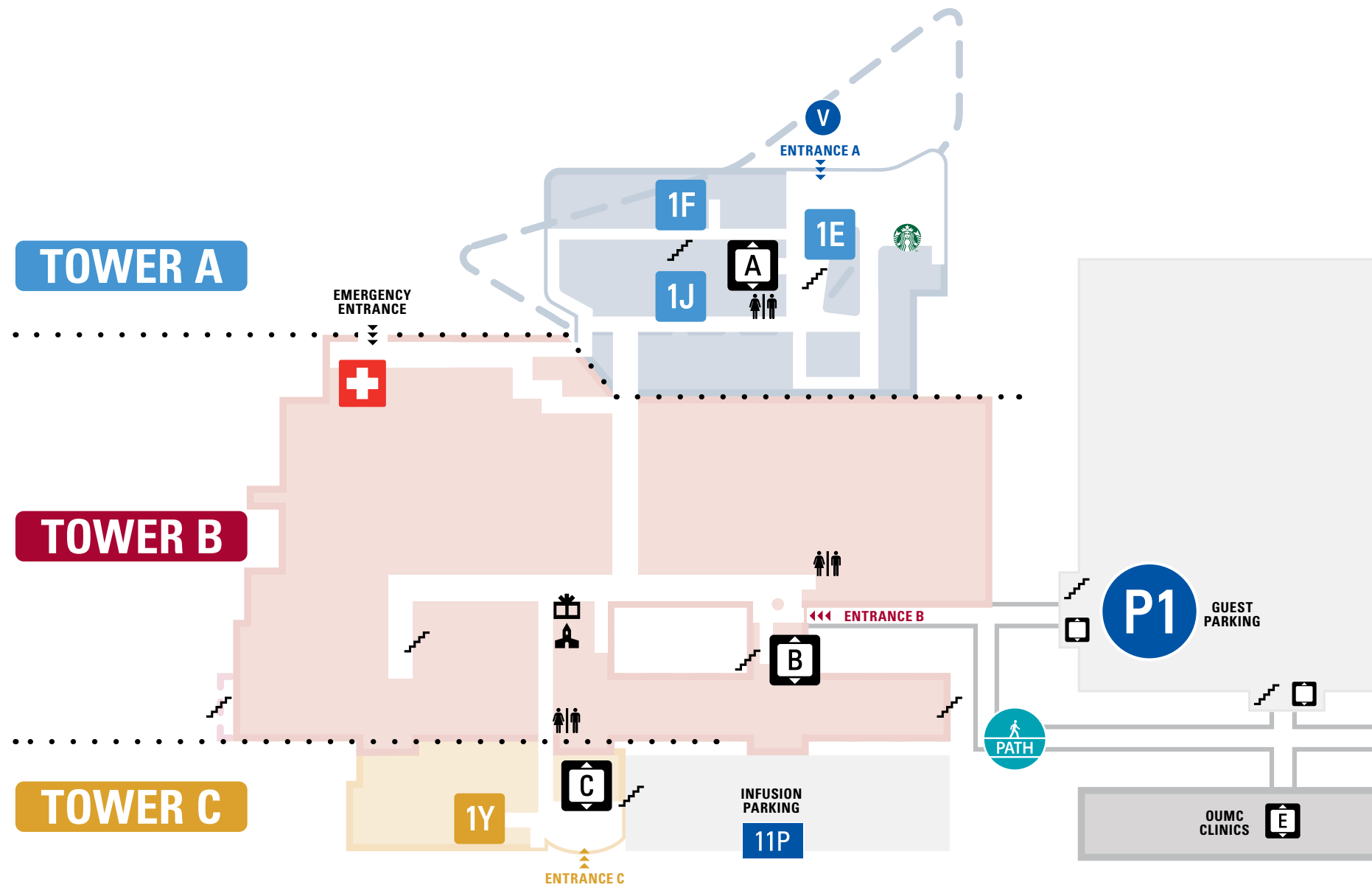

A few high-traffic directories have an alphabetical list of hospital destinations and important amenities.

ID	DEPARTMENT (Alphabetical)	TOWER / ELEVATOR	FLOOR	ROOM #
🏠	Administration	C	L	
1E	Admitting	A	1	
1J	Blood Bank	A	1	
8F	Cardiovascular Institute	A	8	8112 - 8158
🏛️	Chapel	B	1	
1F	Conference Center	A	1	
2T	Continuous Care Nursery	B	2	
🏥	Emergency	B	1	
2S	Endoscopy/Bronchoscopy/PFT	B	2	
2R	Family Lounge	B	2	
🛍️	Gift Shop	B	1	
🌿	Healing Garden	A	4	
LJ	Imaging / Gamma Knife	A	L	
1Y	Infusion Services	C	1	
5W	Inpatient Trauma	B	5	500 - 580
6F	Medicine ICU	A	6	6112 - 6158
6W	Medicine Specialty	B	6	600 - 681
7W	Medicine Specialty	B	7	700 - 771
2U	Neurosciences ICU	B	2	2060 - 2082
3W	Neurosciences/Stroke Unit	B	3	300 - 357
5F	Oncology	A	5	5112 - 5158
☕	Sooner Café	B	L	
☕	Starbucks	A	1	
2F	Surgery Waiting & Recovery	A	2	
3F	Surgery Waiting & Recovery	A	3	
2Q	Surgical ICU	B	2	2001 - 2015
7F	Surgical Oncology	A	7	7112 - 7158
4W	Surgical Specialty	B	4	452 - 481
4U	Transplant Services	B	4	400 - 431
2P	Trauma ICU	B	2	2016 - 2034
V	Valet / Main Lobby	A	1	Entrance A
P1	Parking Garage	B	1	Entrance B
11P	Parking Lot	C	L	Entrance C

Wayfinding Signage for University of Oklahoma Medical Center



Comprehensive Facility Directory
W.O.1.B



Wall Directional (Snap-Frame)
W.R.8



Comprehensive Facility Directory (Small)
W.O.2

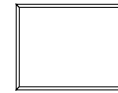

Wall Directional w/ Map (Snap-Frame)
W.R.8.B



Facility Directory
W.O.1



Overhead Directional
W.R.11

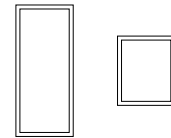

Elevator Cab Directory
W.O.4

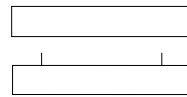

Overhead Destination
W.D.3

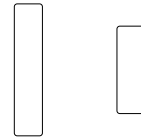

Elevator & Floor ID
W.O.8

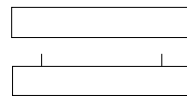

Gateway
W.D.7

Square ID

Hospital Destinations (UOMC & OCH)



TOWER A



TOWER B



TOWER C

OVERVIEW

This ID is for hospital destinations. Currently in production for UOMC and intended to be implemented at OCH in the future. The simple square with rounded corners is meant to be more a graphic paired with destination naming rather than a stand-alone sign or graphic. This ID will be mostly seen on wayfinding tools like destination overheads, wall directionals, maps and handout cards.

These IDs will be colored to match the Tower Color in which the department or destination is located.

LEGACY ID

The Square ID is replacing the original “gumdrop” shape for hospital destinations. Specs of legacy sign are to the right.

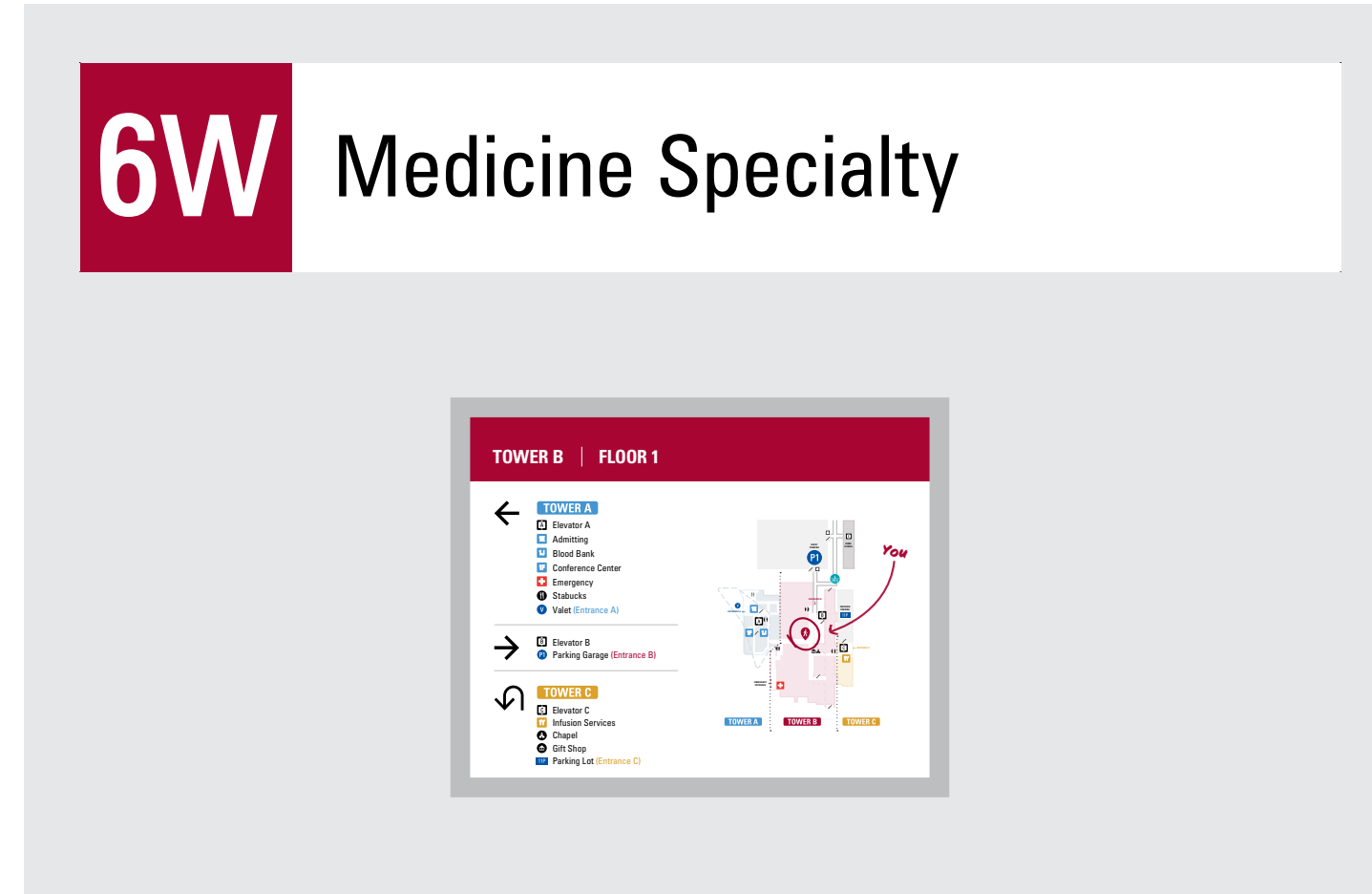

Example of Square ID used on concept Destination Overhead & Wall Directional.

	PMS	2193C
	CMYK	70, 30, 0, 0
	Paint	SW6958 Dynamic Blue
	Vinyl	Oracal 951-053 Light Blue
	PMS	207C
	CMYK	0, 100, 65, 34
	Paint	SW6594 Poinsettia
	Vinyl	Oracal 951-348 Scarlet Red
	PMS	2006C
	CMYK	0, 30, 90, 15
	Paint	SW6691 Glitzy Gold
	Vinyl	Oracal 951-208 Post Office Yellow



LEGACY GUMDROP ID

This ID is still in use in OCH & 2G of OUHP.

INSTALLATION

Wall Mount / 2 Screws
 ADA requires the bottom of sign to be at least 80” from the floor.

DIMENSIONS

12” Tall Cabinet
 First Surface Paint (match clinic or facility colors)
 .25” Thick Acrylic Text
 Back-painted White

Comprehensive Facility Directory (Large)

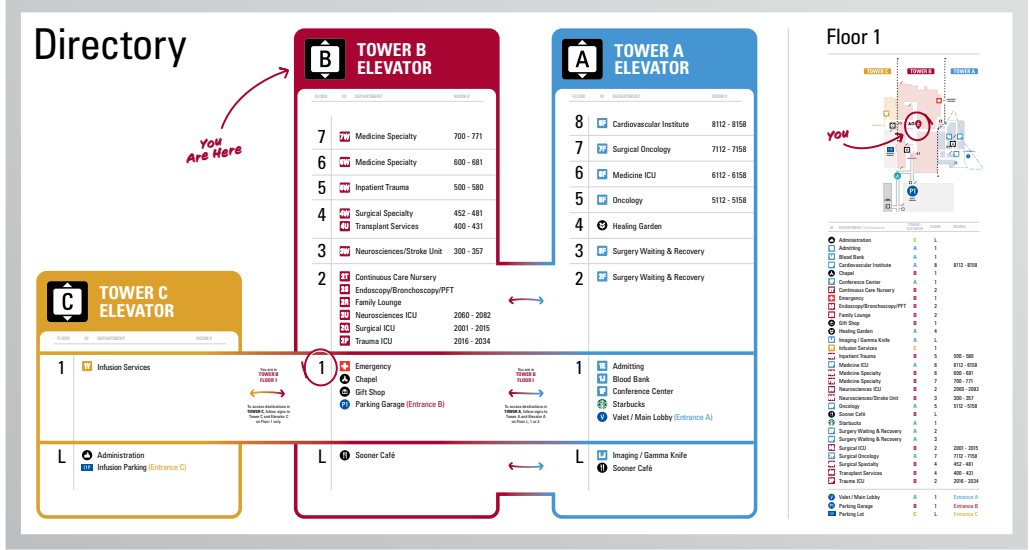

1.5" Depth

PROFILE FOOTPRINT

Comprehensive Facility Directory W.O.1.B

- Hardware:
- Interior frame w/ directory insert
 - Aluminum U-channel 1.5"
 - Aluminum backer .080
 - Integrated channels for lens and backer
 - Removable retainers w/ countersink screws

Acrylic Lens:
 3/8" clear acrylic
 Held by removable 1.5" retainers

Message:
 UHAT-provided Artwork
 Includes contents of Towers A, B and C,
 Floor Map, and Alphabetical Directory

Printed Insert:
 100" x 54"
 51.5" x 97.5" VO

Comprehensive Facility Directory (Small)

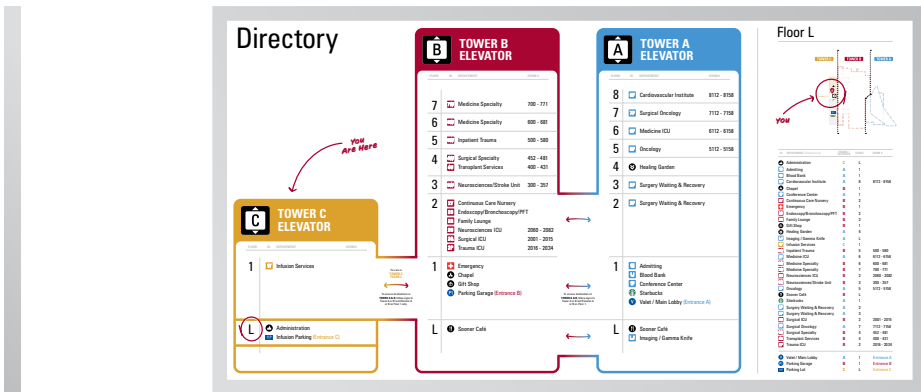

1.5"

Depth

PROFILE FOOTPRINT

Comprehensive Facility Directory (Small) W.O.2

- Hardware:
- Interior frame w/ directory insert
 - Aluminum U-channel 1.5"
 - Aluminum backer .080
 - Integrated channels for lens and backer
 - Removable retainers w/ countersink screws

Printed Insert:
 70" x 38"
 67.5" x 35.5" VO

Acrylic Lens:
 3/8" clear acrylic
 Held by removable 1.5" retainers

Message:
 UHAT-provided Artwork
 Includes contents of Towers A, B and C,
 Floor Map, and Alphabetical Directory



Facility Directory

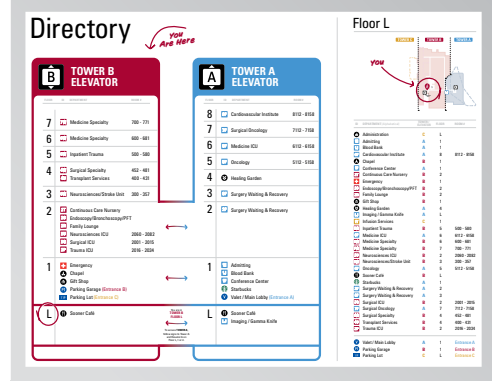

1.5"

Depth

PROFILE FOOTPRINT

Facility Directory W.O.1

- Hardware:
- Interior frame w/ directory insert
 - Aluminum U-channel 1.5"
 - Aluminum backer .080
 - Integrated channels for lens and backer
 - Removable retainers w/ countersink screws

Printed Insert:
 48" x 38"
 45.5" x 35.5" VO

- Acrylic Lens:
 1/4" clear acrylic
- Message:
 UHAT-provided Artwork
 Includes contents of Towers A and B (not C),
 Floor Map, and Alphabetical Directory

Elevator Cab Directory

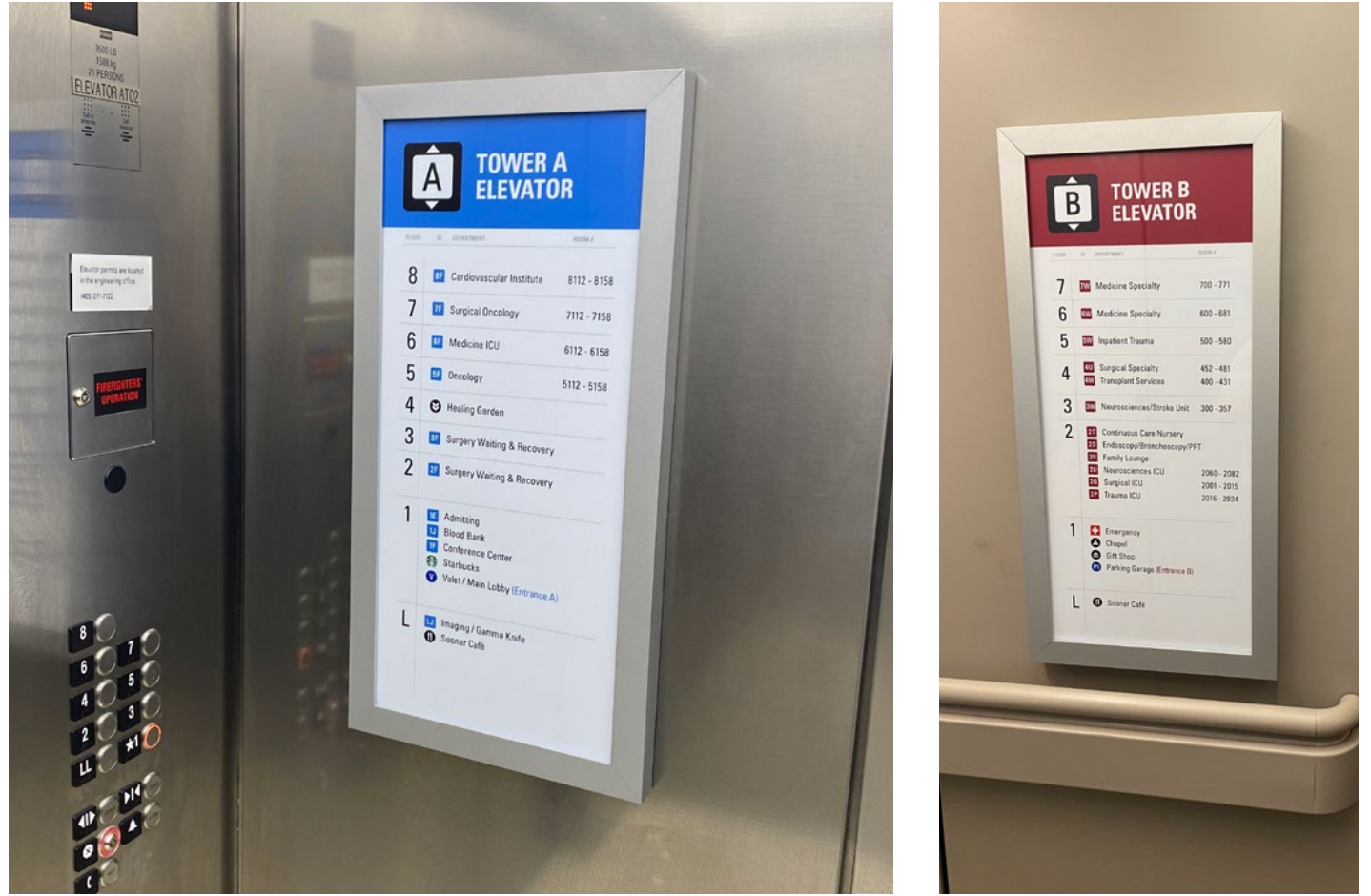
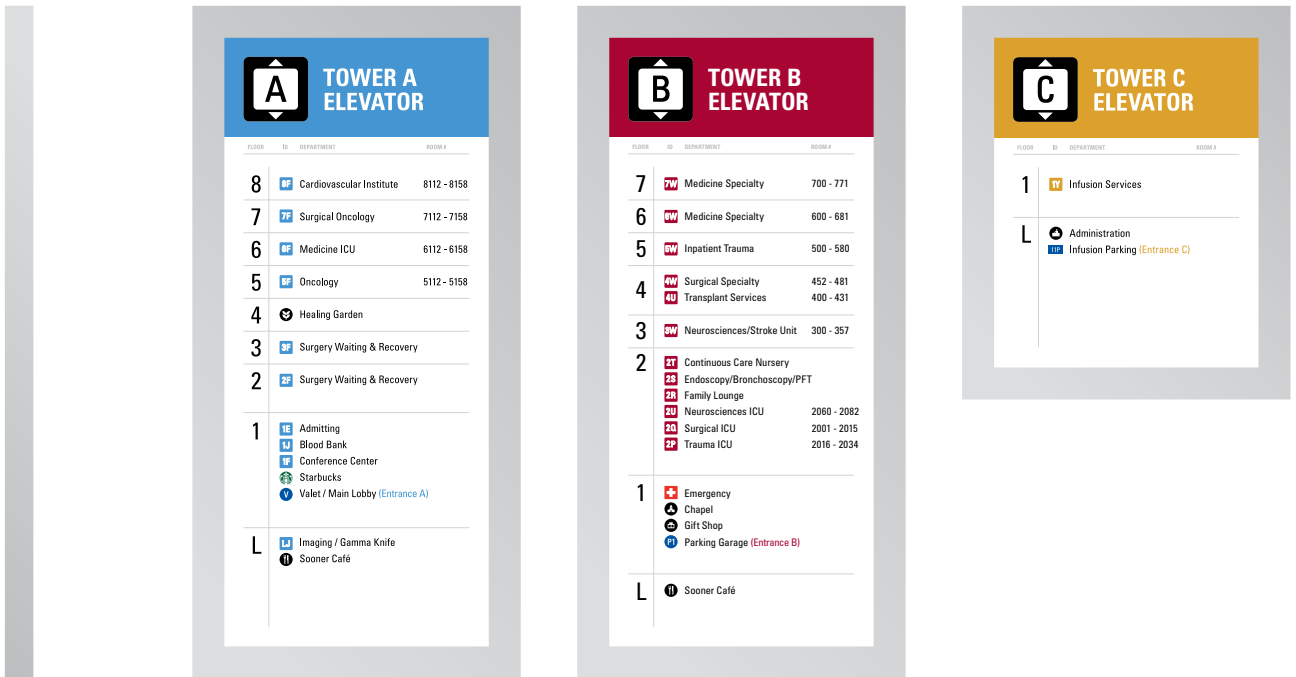

1.5" Depth

PROFILE FOOTPRINT

Elevator Cab Directory W.O.4

- Hardware:
- Interior frame w/ directory insert
 - Aluminum U-channel 1.5"
 - Aluminum backer .080
 - Integrated channels for lens and backer
 - Removable retainers w/ countersink screws

- Acrylic Lens:
- 1/4" clear acrylic
- Message:
- UHAT-provided Artwork
 - Includes contents of one tower

Printed Insert:
15" x 31"
~12" x 28" VO

Elevator & Floor ID

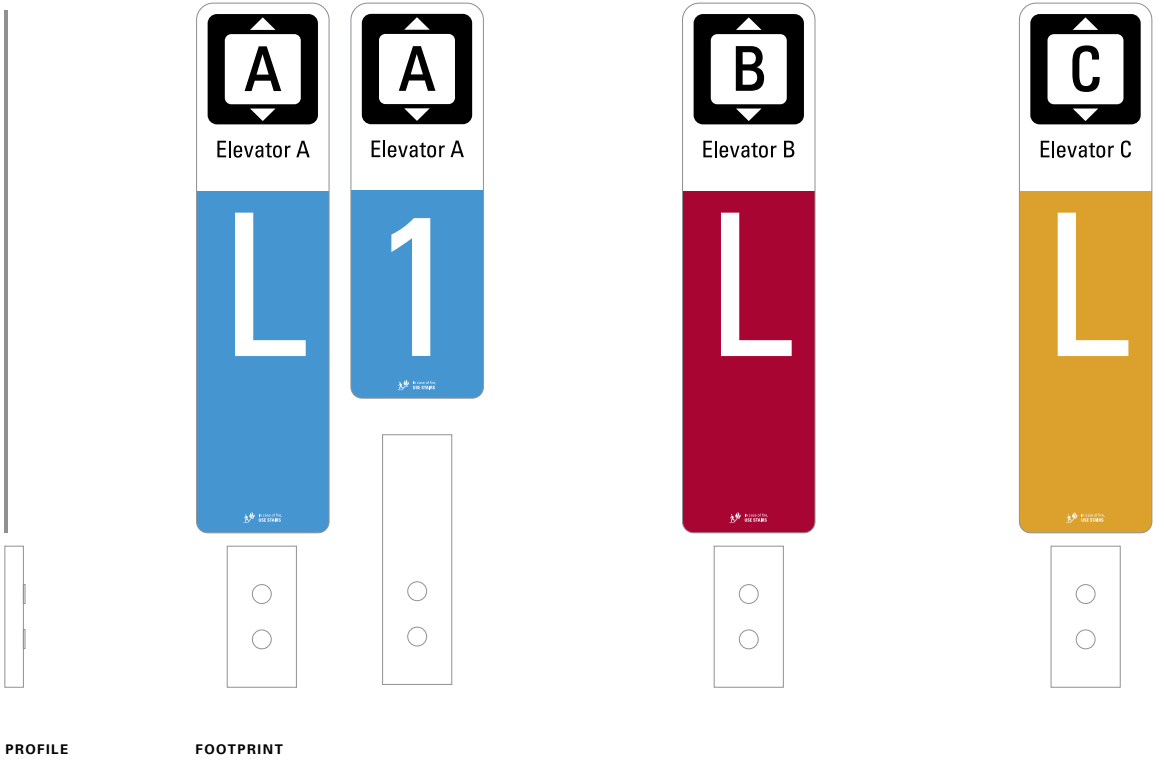

Elevator & Floor ID W.O.8

1/4" Acrylic, Back-printed and back-painted
w/ 1.5" Radius Corners

Tall 12" x 48"
Short 12" x 36"

Message:
UHAT-provided Artwork
Elevator ID & Floor Number on Tower Color
"Use Stairs" verbiage & graphic included, unless
otherwise specified to be removed

Install:
VHB tape & Silicone
Position 1" above call button enclosure

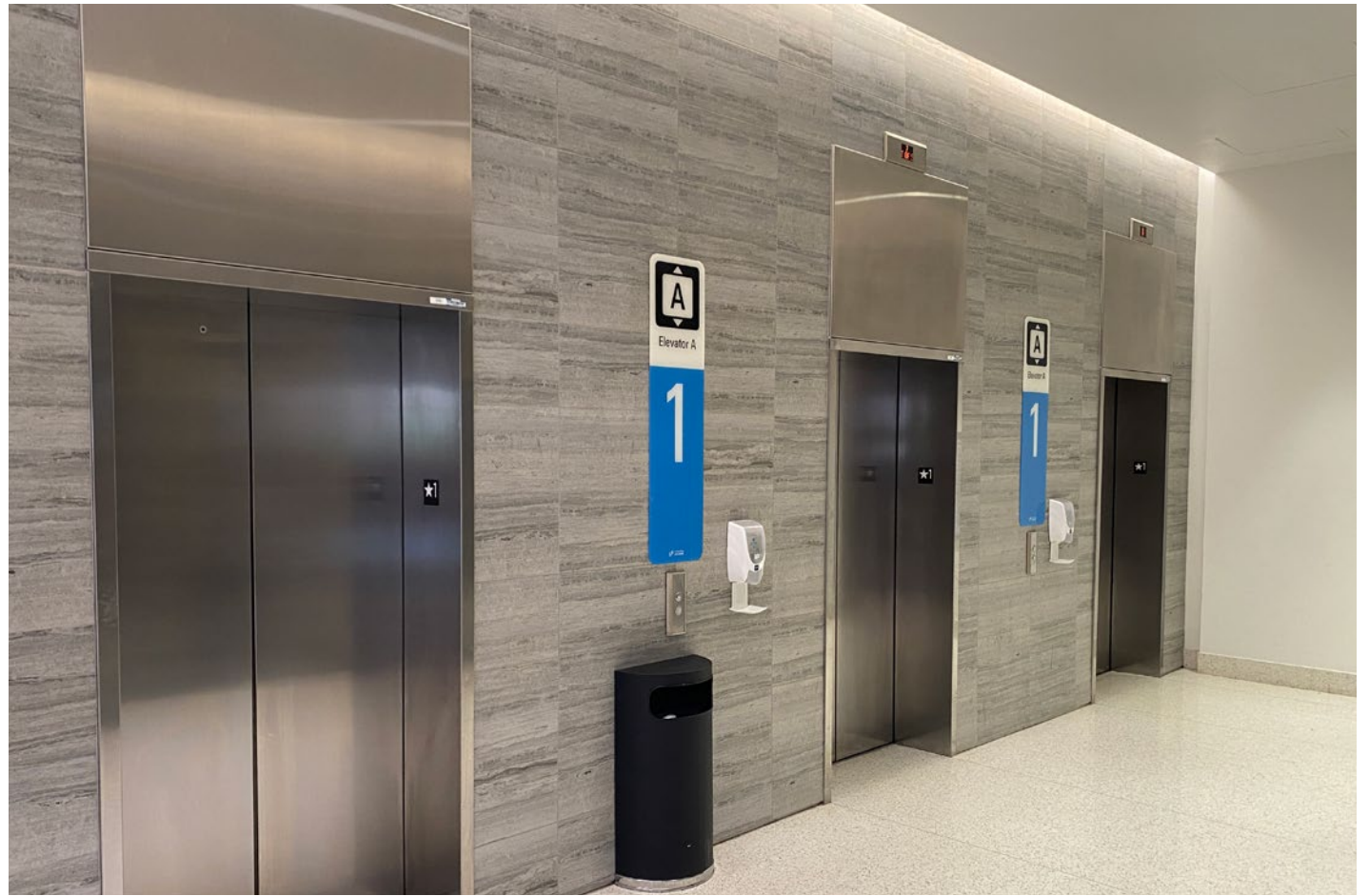

Overhead Directional

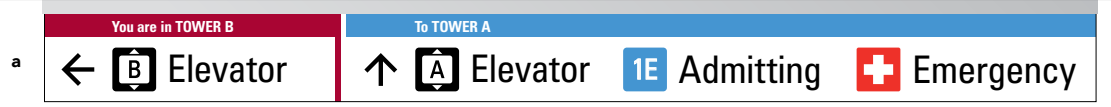
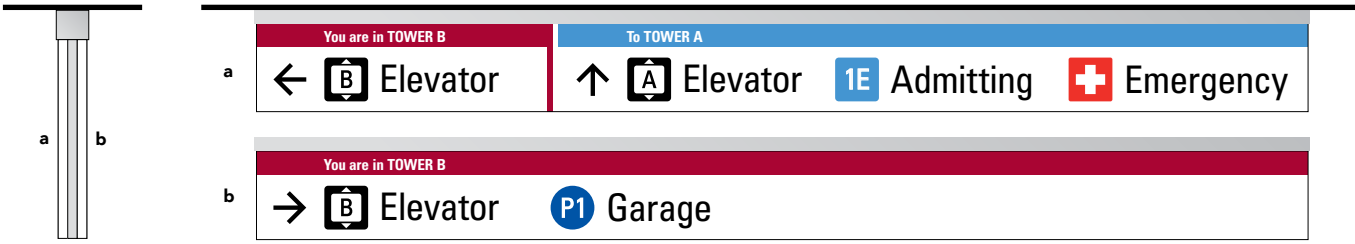

96" x 8"



96" x 8"

PROFILE FOOTPRINT

Overhead Directional W.R.11

Print and install new vinyl messaging using existing overhead directional sign body. Most are double-sided.

Printed Opaque Vinyl w/ Matte Lamination
Width Range: 40" - 120"
Height Range: 8.5" - 9.5"

- UHAT Install:
- Remove old vinyl.
 - Start new vinyl application in the top-left.
 - Trim excess vinyl from right and bottom edges.

- Message:
UHAT-provided Artwork
Hierarchy of Messaging:
- Tower ID
 - Elevator Landmarks
 - Emergency
 - Department IDs
 - Parking



Gateway

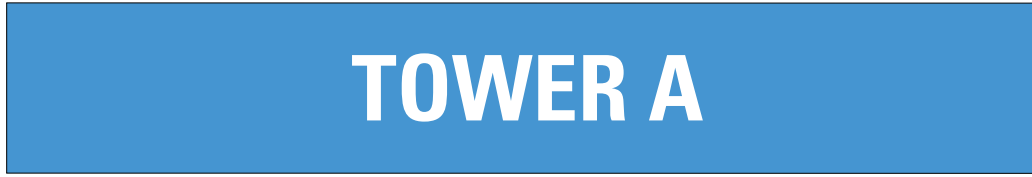
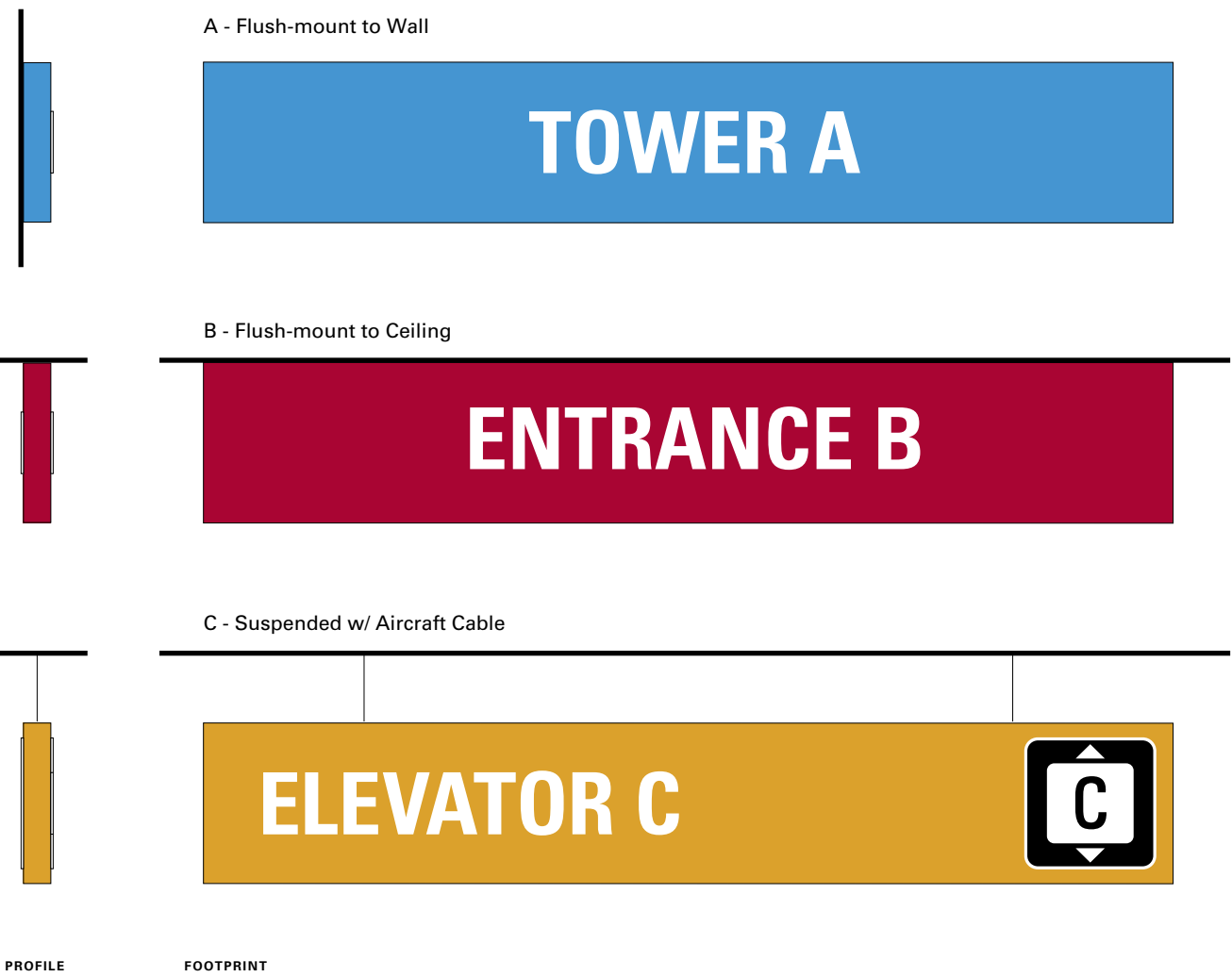

Gateway W.D.7

Signs to identify the "Gateways" of facility entrances, tower location, and elevator landmarks. These signs will likely never change messaging.

Dimensions & Hardware:
72" x 12" x 2"
Square Tube Aluminum Cabinet
Minimal seams for monolithic look.
Paint corresponding tower color.

Message:
UHAT-provided Artwork
1/8" Acrylic Text or Symbols, White and Black

Install:
Flush-mount to Wall (1-sided)
Flush-mount to Ceiling (2-sided)
Suspended w/ Aircraft Cable (2-sided)



Destination Overhead

A - Flush-mount to Wall



B - Flush-mount to Ceiling



C - Suspended w/ Aircraft Cable

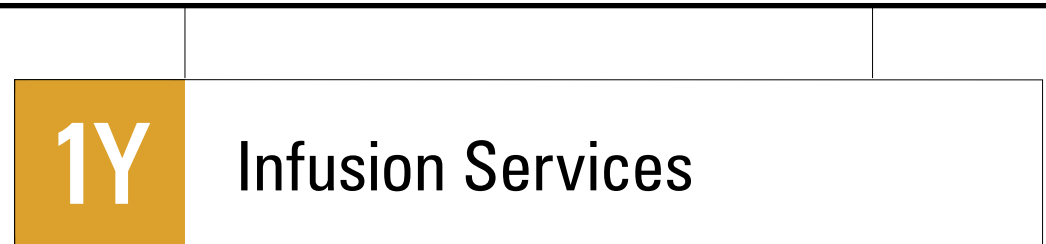

PROFILE FOOTPRINT

Destination Overhead W.D.3

Signs to indicate a department destination.
Made to efficiently update the sign face/messaging.

72" x 12" x 2"
Aluminum square tube frame, painted MP51698 metallic
Aluminum Panels w/ printed opaque vinyl face, matte laminate

Message:
UHAT-provided Artwork
72" x 12"
Printed Opaque Vinyl w/ Matte Lamination

Install:
Flush-mount to Wall (1-sided)
Flush-mount to Ceiling (2-sided)
Suspended w/ Aircraft Cable (2-sided)



Wall Directional w/ Map

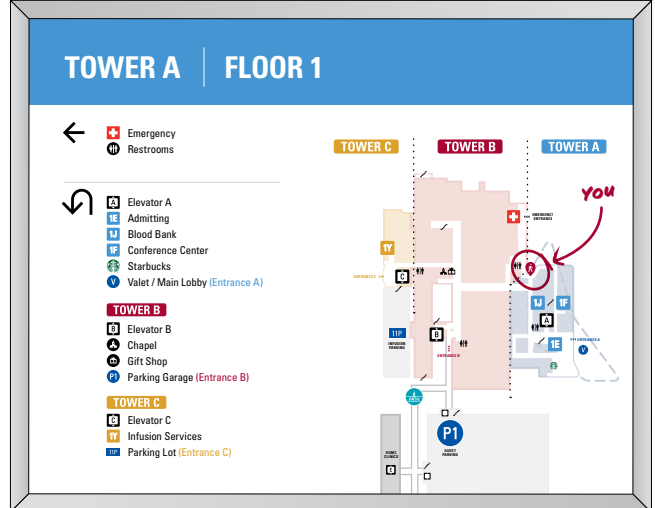

PROFILE FOOTPRINT

Wall Directional w/ Map W.R.8.B

22" x 28" Snap Frame Sign Holder
25mm Profile - Silver
Protective non-glare lens included

Footprint:
23" x 29.5"

Printed Insert:
22" x 28"

Message:
UHAT-provided Artwork
Tower-colored header w/ Tower and Floor info.
Directional info for nearby or important destinations.
Heads-up Map.

Install:
UHAT install

Wall Directional

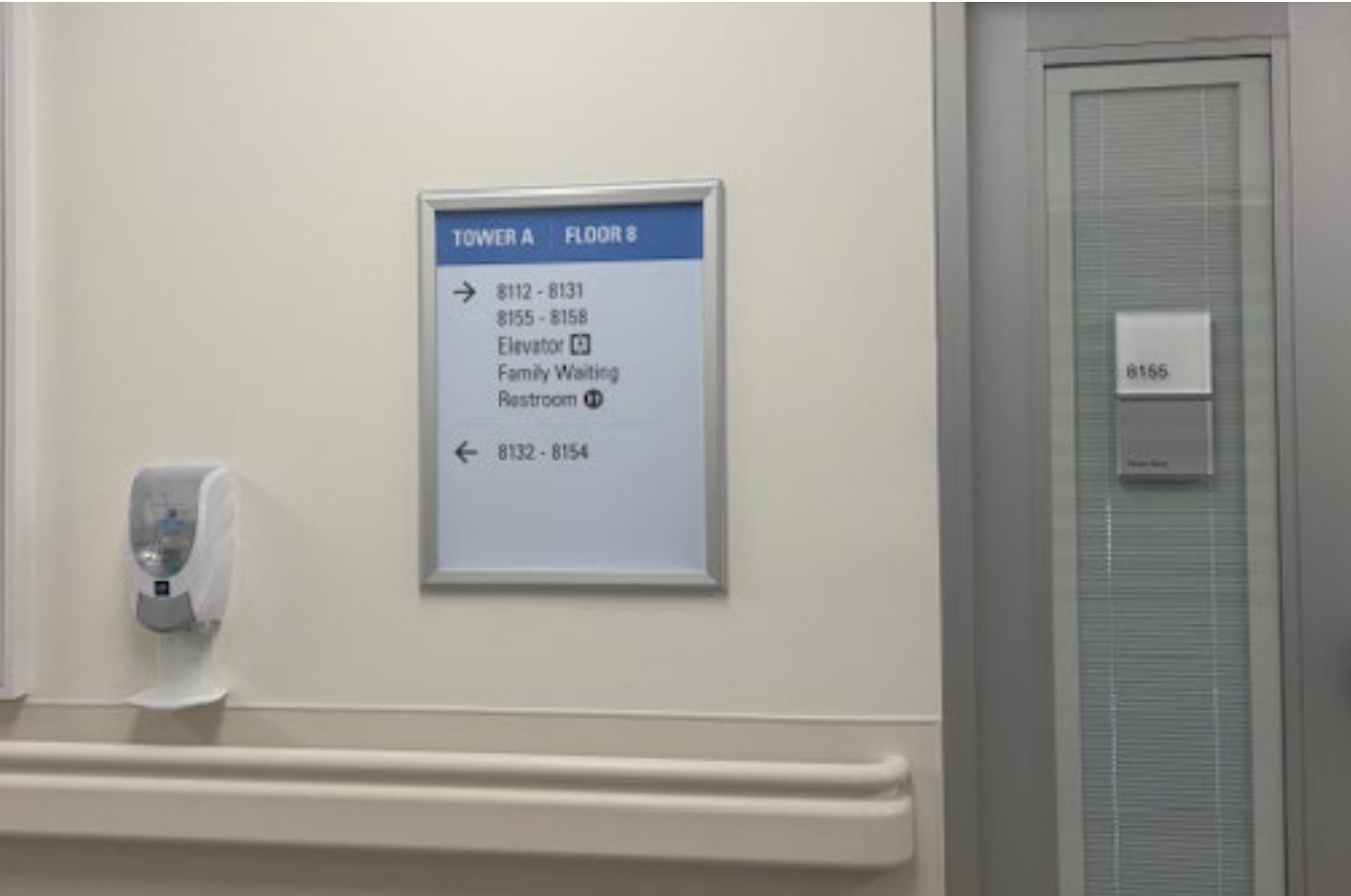
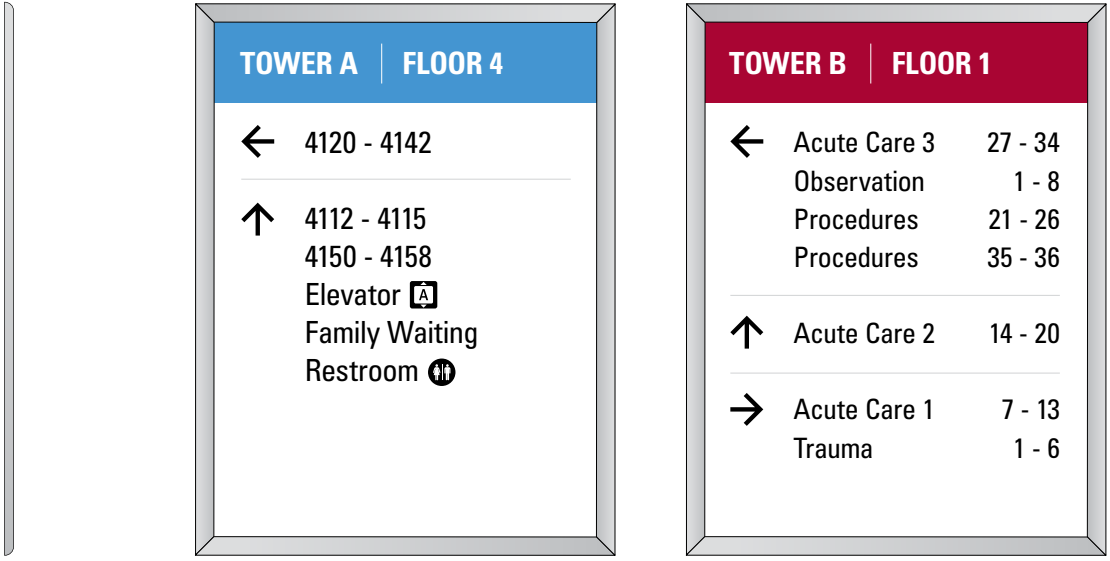

PROFILE FOOTPRINT

Wall Directional W.R.8

18" x 24" Snap Frame Sign Holder
25mm Profile - Silver
Protective non-glare lens included

Footprint:
19.3" x 25.3"

Printed Insert:
18" x 24"

Message:
UHAT-provided Artwork
Tower-colored header w/ Tower and Floor info
Directional info for patient rooms & other relevant destinations.

Install:
UHAT install

Informational

- Snap Frames
- Policies, Disclosures & Legal
- Access Support
- Hanging Labels
- Magnetic & Printed Labels
- Slider (In Use / Vacant)
- Name Plates
- Office Spinner
- Wheelchair Signs
- Infection Control Kiosk
- Receiving & Delivery
- Hydration Station
- Charging Station
- Magnetic Clips (pack of 10)
- Coat Hooks



Snap Frames



OVERVIEW

The Snap Frame is a simple and sleek and sturdy wall-mounted frame that has an easy to update insert with plastic lens. This product is good for larger signs that may update occasionally.

AVAILABLE SIZES

- 11" x 17"
- 18" x 24"
- 22" x 28"
- 24" x 36"

MESSAGING

Custom messaging for clinic, department or tenant.

SPECS

- Silver
- Frosted, Non-Glare Lens
- Print Insert

Policies, Disclosures & Legal



OVERVIEW

When several documents are required by law or operating entity to be publicly displayed, these silver "Snap Frames" provide a clean and professional look while also allowing for quick and affordable replacement of the paper insert.

MESSAGING

Custom messaging for clinic, department or tenant.

SPECS

11" x 17" Silver "Snap Frame"
Print Insert

INSTALLATION

When in groups of 6: (as shown above)
2 Rows of 3 Frames
2" Spacing between frames
45.5" from the floor

RECOMMENDED LAYOUTS

Hospital, ER, or Clinic Documents

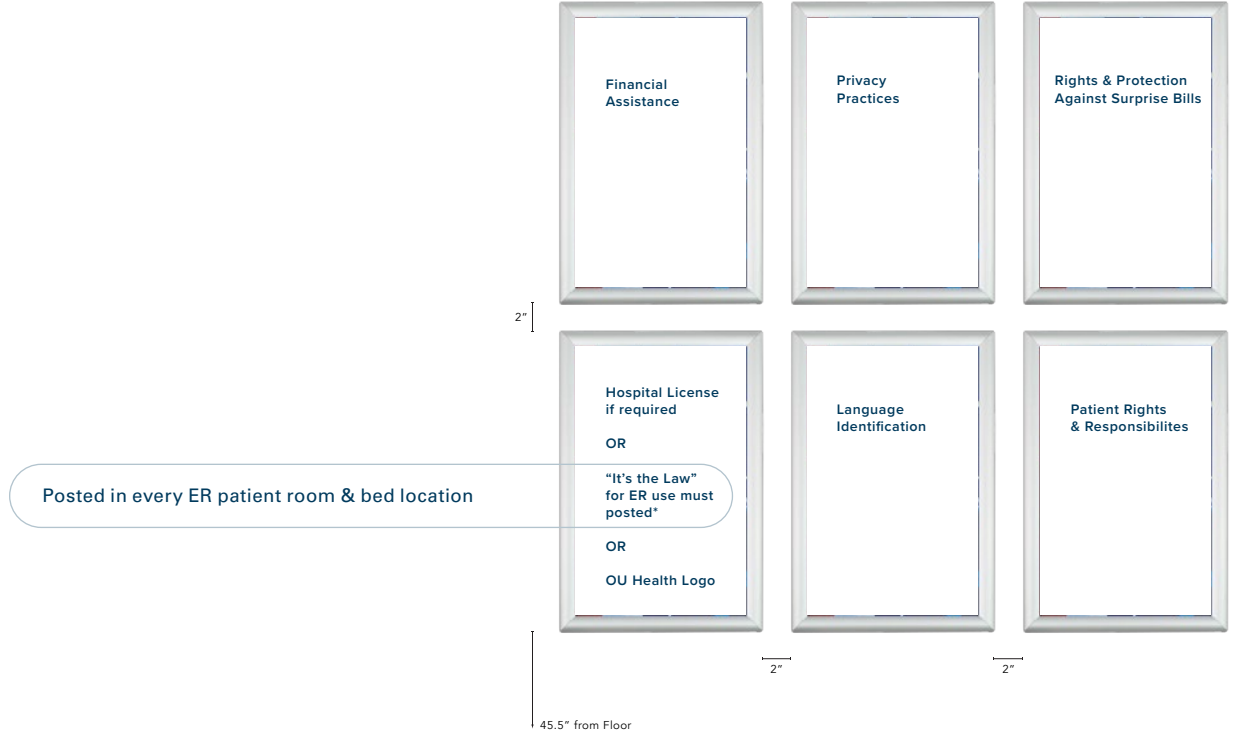

Posted in every ER patient room & bed location

Pharmacy Documents



Access Support

**PRESS
BUTTON
FOR ENTRY**

Please stand in front of the camera for the door to unlock.



OVERVIEW

These signs typically pair with an access controlled door, badge reader or button. These signs are meant to blend well with the facility standard signage.

MESSAGING

Messaging changes depending on access restrictions or entry requirements.

SPECS

5" x 5" Back-printed
1/4" Acrylic

INSTALLATION

VHB
If installed on glass, modesty panel required.

**CCAN
EMPLOYEES
ONLY**

All other students, guests or staff use Elevator T on floor 3.

**PRESS
BUTTON
FOR ENTRY**

Please stand in front of the camera for the door to unlock.

**BADGE
ACCESS
REQUIRED**

After both sets of doors are closed, scan badge for access.

Hanging Labels

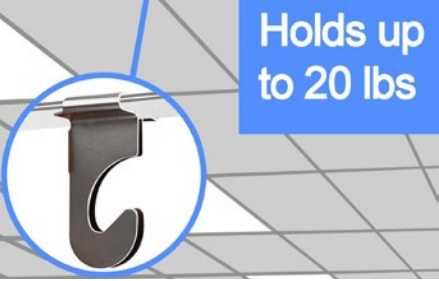
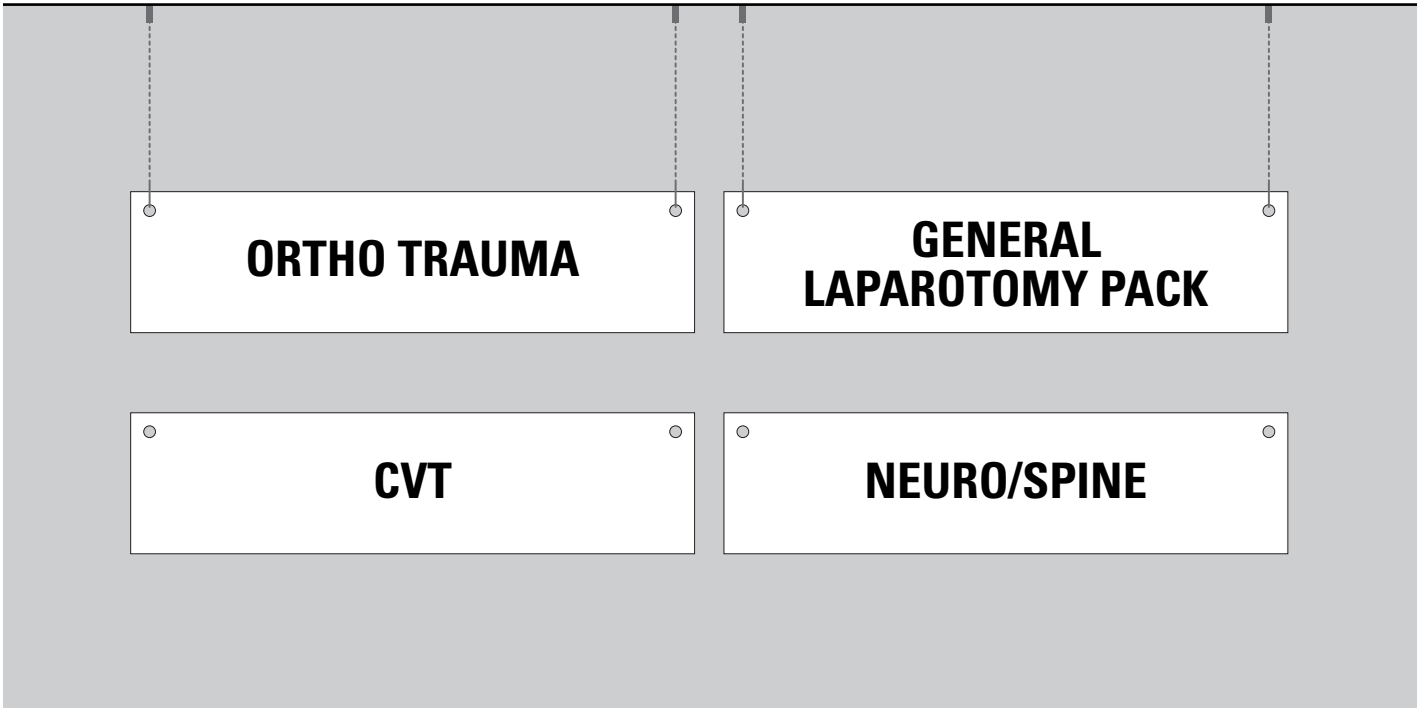

OVERVIEW

A large label for back-of-house storage organization that can hang above a grouping of shelves. This type of label has been used to identify sections of products, inventory or ownership of items in a storage setting.

DIMENSIONS

24" x 6"

SPECS

- 3/16" Gator Board
- Digital print
- 1- or 2-sided

Magnetic or Printed Labels

DR. NAME

PHARMACY



OVERVIEW

A small magnetic or printed vinyl/acrylic sign used to identify providers in clinic spaces or storage shelving.

With metal baskets or shelving, magnets are ideal to allow for adjustments of provider spaces or reorganization of inventory. Vinyl or acrylic can be affixed in more permanent situations.

DIMENSIONS

6" x 1"

MESSAGE

.5" Text

Slider (In Use / Vacant)



OVERVIEW

An aluminum frame with plastic slider insert that reveals either "In Use" or "Vacant" text below. These signs are good for rooms that need help promoting occasional privacy.

INSTALL

Foam Tape (typically included)

Name Plates



OVERVIEW

Additional signage for rooms that may be shared by multiple physicians or purposes. The plastic, engraved name plate easily slides in and out of the aluminum track for quick customization.

SPECS

2" x 8" Brushed Aluminum

Black text, all caps, sans serif font

Office Spinner

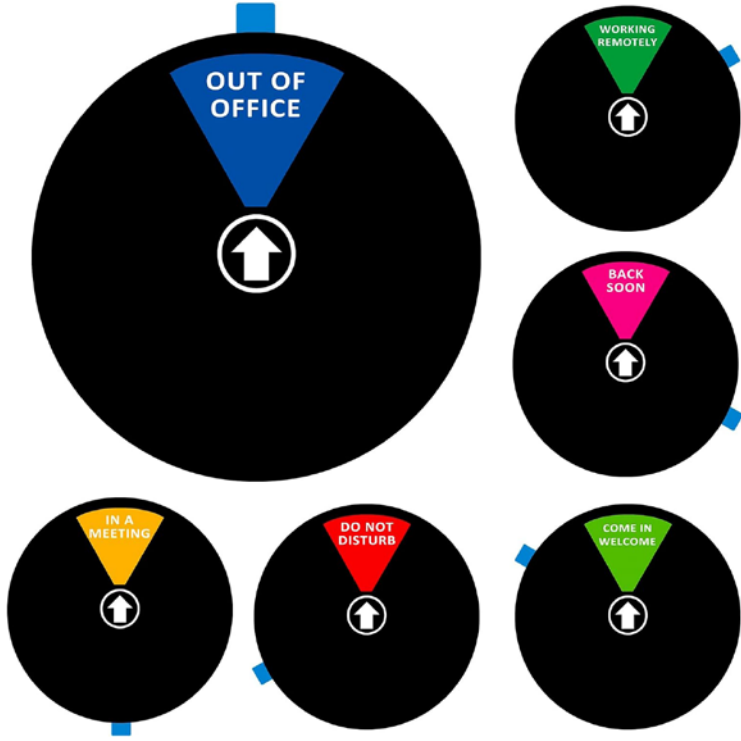

OVERVIEW

A plastic sign for an office setting to help communicate your availability or status. Includes 6 messages that are visible as the internal sign panel is rotated to reveal the desired message.

INCLUDED MESSAGING

Do Not Disturb/Come in Welcome/Out of Office/in a Meeting/ Back Soon/Working Remotely

SPECS

Diameter: 6"
Depth: .3"

INSTALL RULES

Install 1" above office room sign (as shown above)

DO NOT INSTALL at any other room that is not considered an office. Do not install at cubicles, reception desks, Telecom, storage, restrooms, break rooms, copy rooms, library, mechanical room, stairwell or door for a department.

Wheelchair Signs



OVERVIEW

A sign on the back of 1CALL-managed wheelchairs in certain clinic and hospital spaces.

PRODUCT SPECS

- 16.5" x 7.75"
- 4mm Aluminum Composite White
- 1" Rounded Corners
- Holes .25 (in all 4 corners)

MESSAGE

1CALL branding, phone number and wheelchair number.

INSTALLATION

UHAT install. Black zip ties to metal cage on back.

Infection Control Kiosk



OVERVIEW

These comprehensive kiosks help reduce the spread of germs with mask, tissue, and hands-free hand-sanitizer dispensers. There is also a space at the bottom or on the sides of the kiosk for custom messaging or artwork.

PRODUCT SPECS

23"W x 12"D x 50"H

ART SPECS

Bottom Panel: 17.875" x 28"
Optional Side Panel:

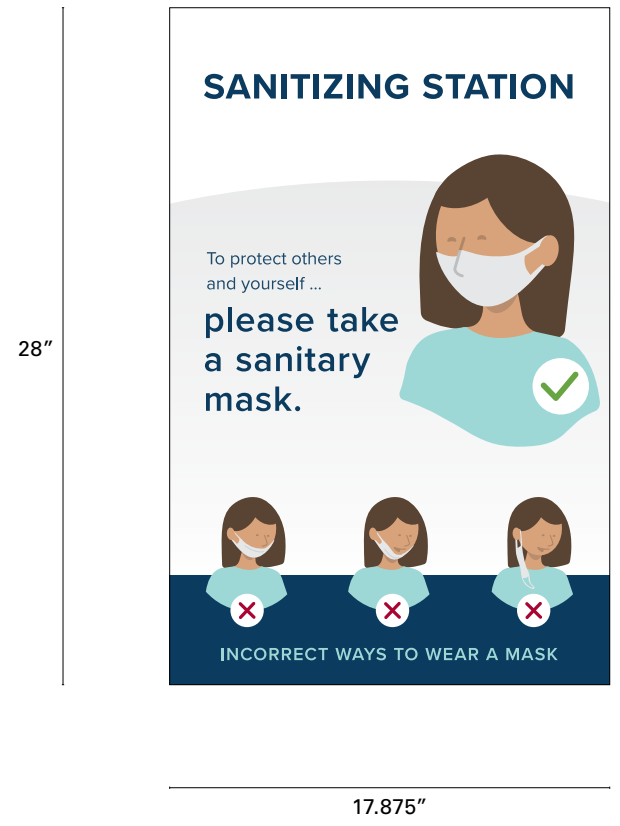

Receiving & Delivery



OVERVIEW

This sign is meant to be hung at the entrance to the part of a building that houses a Receiving and Delivery department. These departments are currently managed by 1CALL Facility Services.

PRODUCT SPECS

Printed Opaque Vinyl (exterior)
or 1/8" Back-printed acrylic (interior)
12" x 12.5"

INSTALLATION

First surface on side-light glass, if available. Otherwise, install on door without crowding other decals or required safety or ADA messaging.

Hydration Station

HYDRATION STATION

Please store personal
drinks in here.

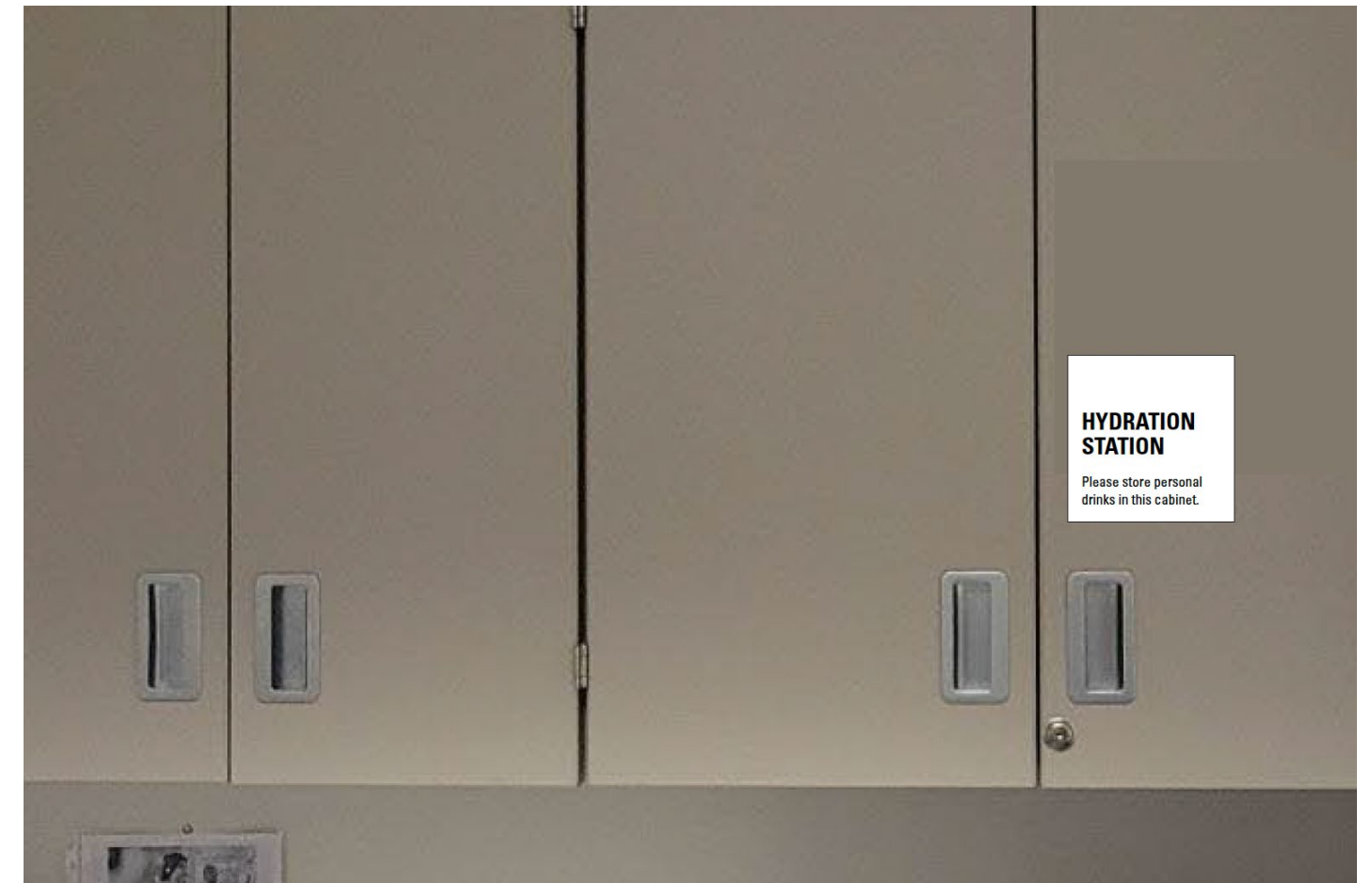

OVERVIEW

A clearly marked hydration station in a healthcare space is required to keep personal drinks separate from clinic equipment or from patient-use areas.

PRODUCT SPECS

1/8" Back-printed acrylic (interior)
6" x 6"

Charging Station

Charging Station 

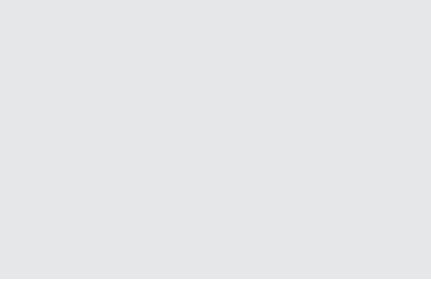

OVERVIEW
A simple vinyl label for a courtesy charging stand.

PRODUCT SPECS
Printed Vinyl
18" x 2"

INSTALLATION
Vinyl install on top edge of stand. Trim around top-left and right corners after vinyl install.

Magnet Clips (Pack of 10)



OVERVIEW

This metal clip with a strong magnet can be placed on door jambs and other metal surfaces in order to display a temporary message. Strong magnet can hold up to 60-page newspaper or single-sheet note.

SPECS

Anti Scratch Magnet Pads Included

Diameter: 1.4"

Length: 1.8"

Width: 0.95"

Coat Hooks



OVERVIEW

A wall-mounted coat rack featuring 3 foldable hooks on a slim track. Aluminum hooks have smooth corners and edges.

SPECS

- Length: 9.06"
- Height: 2.36"
- Depth: 0.63"

Safety

Graphic Safety
Text Only Safety
Instructional Support
Emergency Exit - Vinyl Bands
Authorized Personnel Only - Vinyl Bands
Automatic Door - Vinyl Bands



Graphic Safety

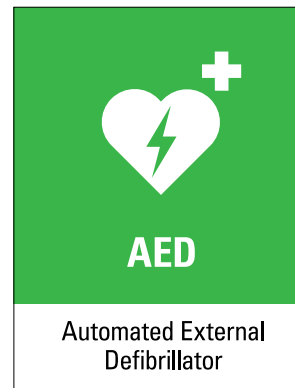
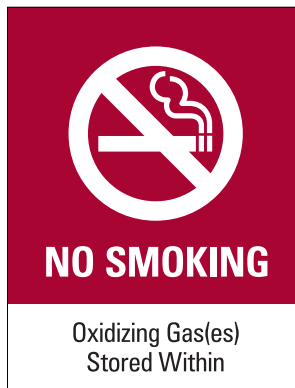
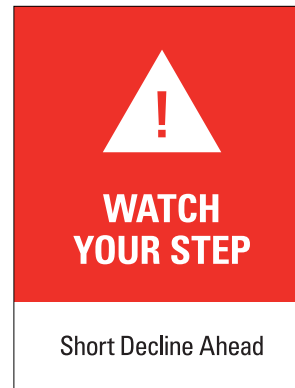
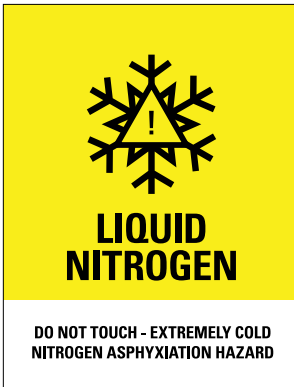
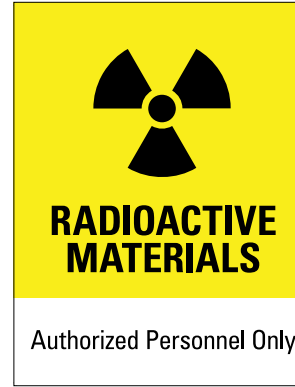

OVERVIEW

These Graphic Safety Signs are mostly for drawing attention to potentially hazardous situations with graphic symbols and supporting text.

MESSAGING

A symbol is preferred in the top block to communicate the warning regardless of language. The lower block is for more detailed copy that expounds on the symbol/statement in the top block. If no symbol is available, refer to the "text-only safety signs" on the next page.

SPECS

8.5" x 11"
1/8" Acrylic
Back-printed

INSTALLATION

Wall mount with VHB Tape

Text Only Safety

NITROUS OXIDE

Positive Pressure Gases
No Smoking or Open Flame

Room may have insufficient oxygen.
Open door and allow room to ventilate before entering.

CHEMICAL STORAGE AREA

Authorized Personnel Only

FORMALDEHYDE IN LAB AREA

Irritant & Potential Cancer Hazard

STAIRS CLOSED DUE TO CONSTRUCTION

Please use other stairwell.

PPE REQUIRED IN LAB

Lab coats, gloves, masks and eye protection required.

PPE REQUIRED IN LAB

Lab coats, gloves, masks and eye protection required.

NO CELL PHONE CALLS

Please refrain from making or taking phone calls in this waiting area.

NO PPE BEYOND THIS POINT

No gloves, lab coats or specimens in this area.

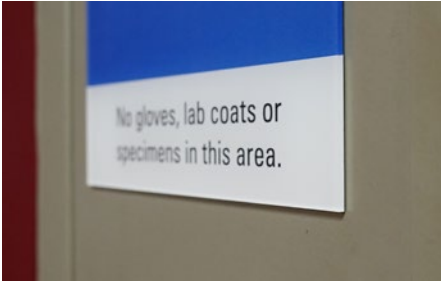

OVERVIEW

These safety signs are mostly for drawing attention to potentially hazardous situations with color and text.

MESSAGING

Similar to the Graphic Safety Signs, the top color block is for an abbreviated message that gets right to the point or highlights the potentially dangerous object or element. Words like WARNING, CAUTION or NOTICE are not preferred as they provide little detail or no actionable information. The lower block is for more detailed copy that expounds on the statement in the top half.

SPECS

8.5" x 11"
1/8" Acrylic
Back-printed

Instructional Support

<p>NO EXIT</p> <p>Authorized Personnel Only</p>	<p>EMERGENCY EXIT ONLY</p> <p>If door is opened, alarm will sound and security will be notified.</p> <p><small>For assistance, call 405-271-CALL(2255).</small></p>	<p>MASKS STRONGLY ENCOURAGED</p> <p>Individuals feeling ill or who have cold and flu symptoms such as runny nose or cough should mask for the safety of others.</p>	 <p>MOTHER FEEDING</p> <p>Do Not Disturb</p>
<p>ACCESS CONTROLLED</p> <p>Each cardholder must scan their own access card for entry.</p> <p><small>If you need access, please call 405-271-CALL(2255) or submit a work order.</small></p>	<p>CONTROLLED ACCESS</p> <p>Guest access to the Children's Atrium </p> <p>Take Elevator  to Floor 2</p>	<p>NO ACCESS TO ATRIUM</p> <p>Please use Elevator  to Floor 2 to access:</p> <p>Atrium / Main Entrance </p> <p>Elevator </p> <p>Parking Garage </p>	 <p>Please, no video or flash photography.</p> <p>Por favor, no hay fotografía de vídeo o flash.</p>

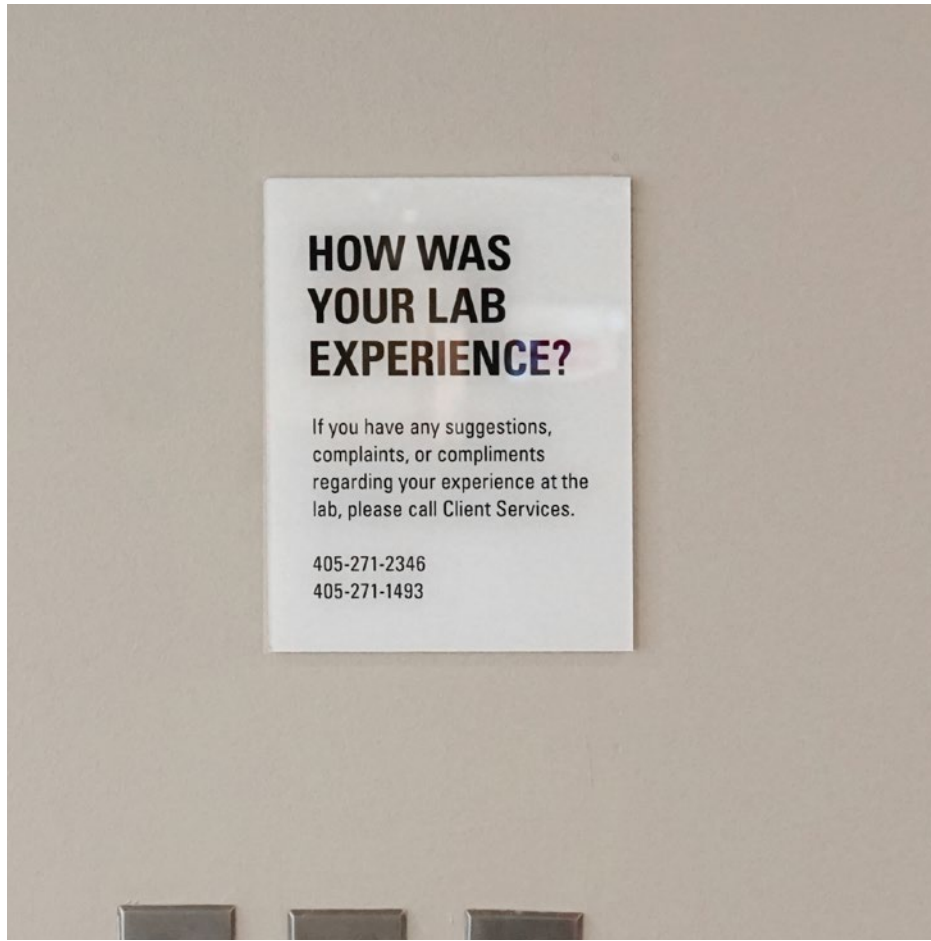
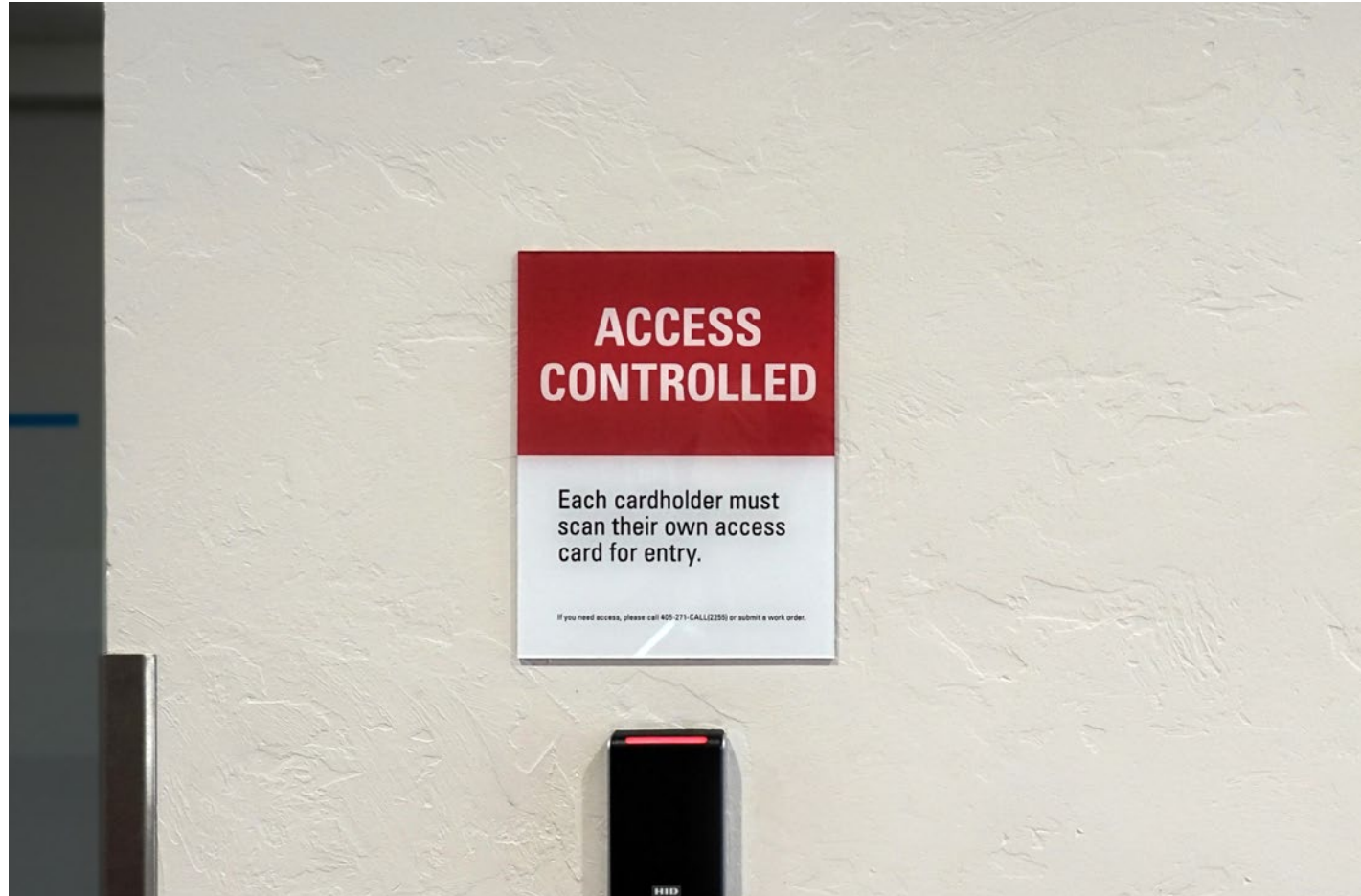

OVERVIEW

Operational Info Signs are for communicating important information or instruction about facility operations. Although simple in design, having the same color block at the top half creates consistency throughout a facility so staff and guests can quickly recognize the signs that have important information.

MESSAGING

Similar to the Graphic Safety Signs, the top color block is for the abbreviated message that gets right to the point. The lower block is for more detailed copy that expounds on the statement in the top half.

SPECS

8.5" x 11"
1/8" Acrylic
Back-printed

INSTALLATION

Wall mount with VHB Tape

Emergency Exit - Vinyl Bands

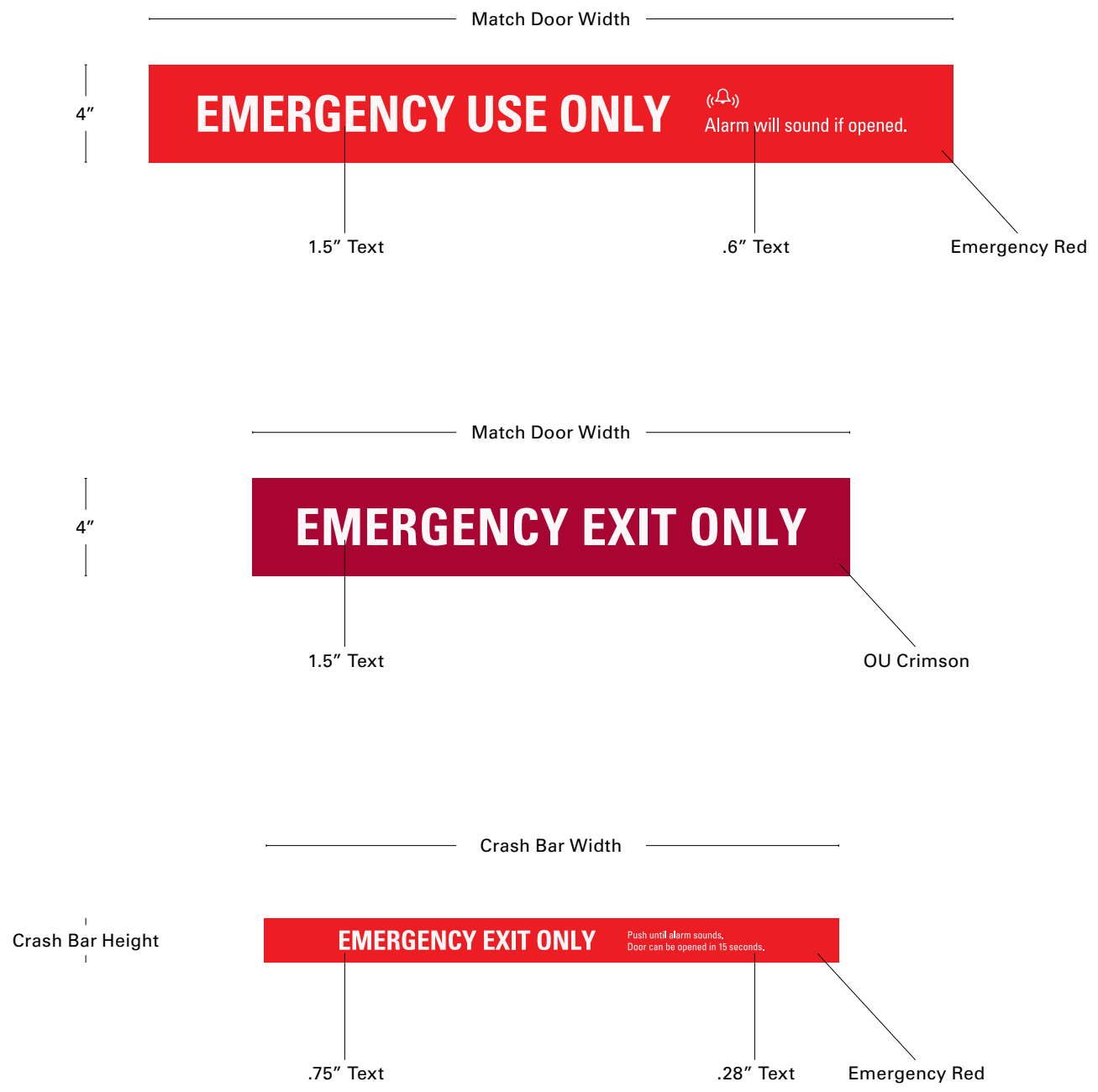

OVERVIEW
A visible vinyl band on door to clearly communicate that a door is for emergencies only.

MESSAGING
1.5" Tall Text
Minimum message: EMERGENCY EXIT ONLY
Secondary message: Include instructions about alarm.

SPECS
4" tall band x Door width
Or match crash bar size

INSTALLATION
First surface install just above crash bar or handle.

Authorized Personnel Only - Vinyl Bands



OVERVIEW

A visible vinyl band on door(s) to clearly communicate to guests not to enter that area.

MESSAGING

1.5" Tall Text
Minimum message: AUTHORIZED PERSONNEL ONLY
Secondary message: Include Symbol for "Do Not Enter"

SPECS

4" tall band x Door Width

INSTALLATION

First surface install near middle of door to leave room for other signage like "Automatic Door: Activate Switch to Operate". If no other signage intended for door, install at or near eye-level.

Automatic Door - Vinyl Bands

Width of Glass in Door

2"

CAUTION: AUTOMATIC DOOR

Primary Sliding Door on Ingress

IN EMERGENCY PUSH TO OPEN

Primary Sliding Door on Egress (or towards emergency exit egress route)

AUTOMATIC DOOR: STAND CLEAR

Secondary Sliding (when sliding door crosses on SAME side)

AUTOMATIC DOOR

Secondary Sliding Door (when sliding door crosses on OPPOSITE side)

STAND CLEAR

Stationary Door (when sliding door crosses on SAME side)

Stationary Door (modesty panel for any door that requires no band)

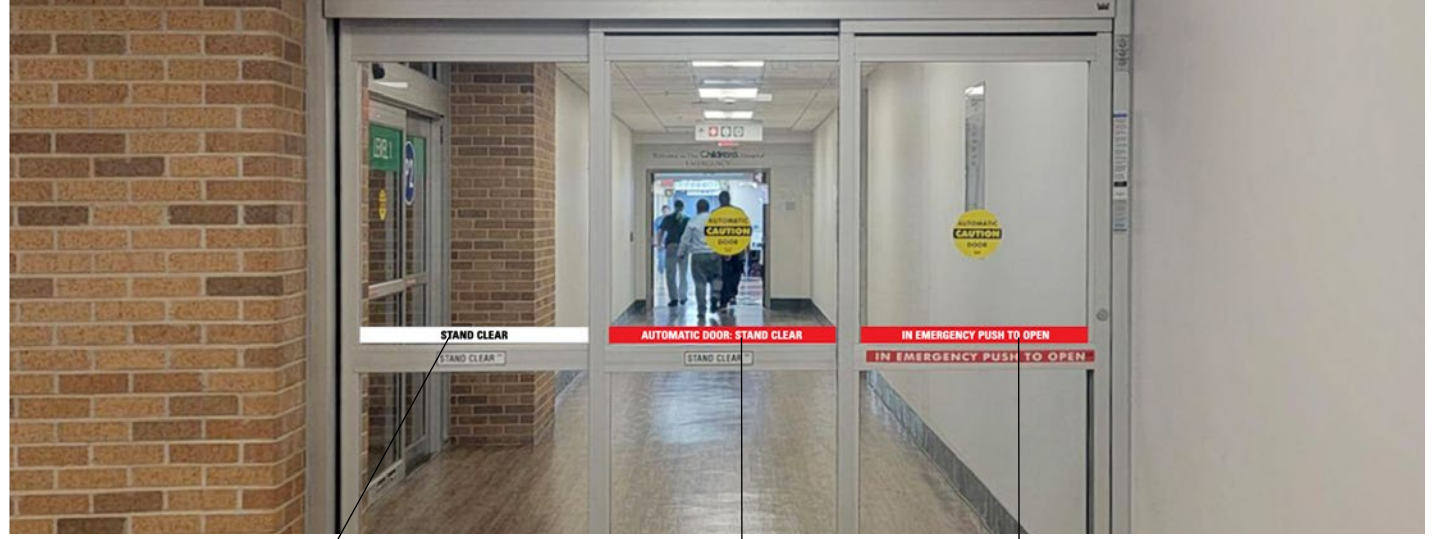

Stationary Door: This Side

STAND CLEAR
28.25" x 2"

Sliding Door 2: This Side

AUTOMATIC DOOR: STAND CLEAR
28.25" x 2"

Sliding Door 1: This Side

IN EMERGENCY PUSH TO OPEN
28.25" x 2"

Stationary Door: Other Side

Sliding Door 2: Other Side

AUTOMATIC DOOR

Sliding Door 1: Other Side

CAUTION: AUTOMATIC DOOR

OVERVIEW

Vinyl bands that alert pedestrians of moving doors and emergency egress procedure if door because unresponsive.

MESSAGING

1" Tall Text
See suggested messaging layout above and example of same layout to the right.

SPECS

2" tall printed opaque vinyl x Door Width

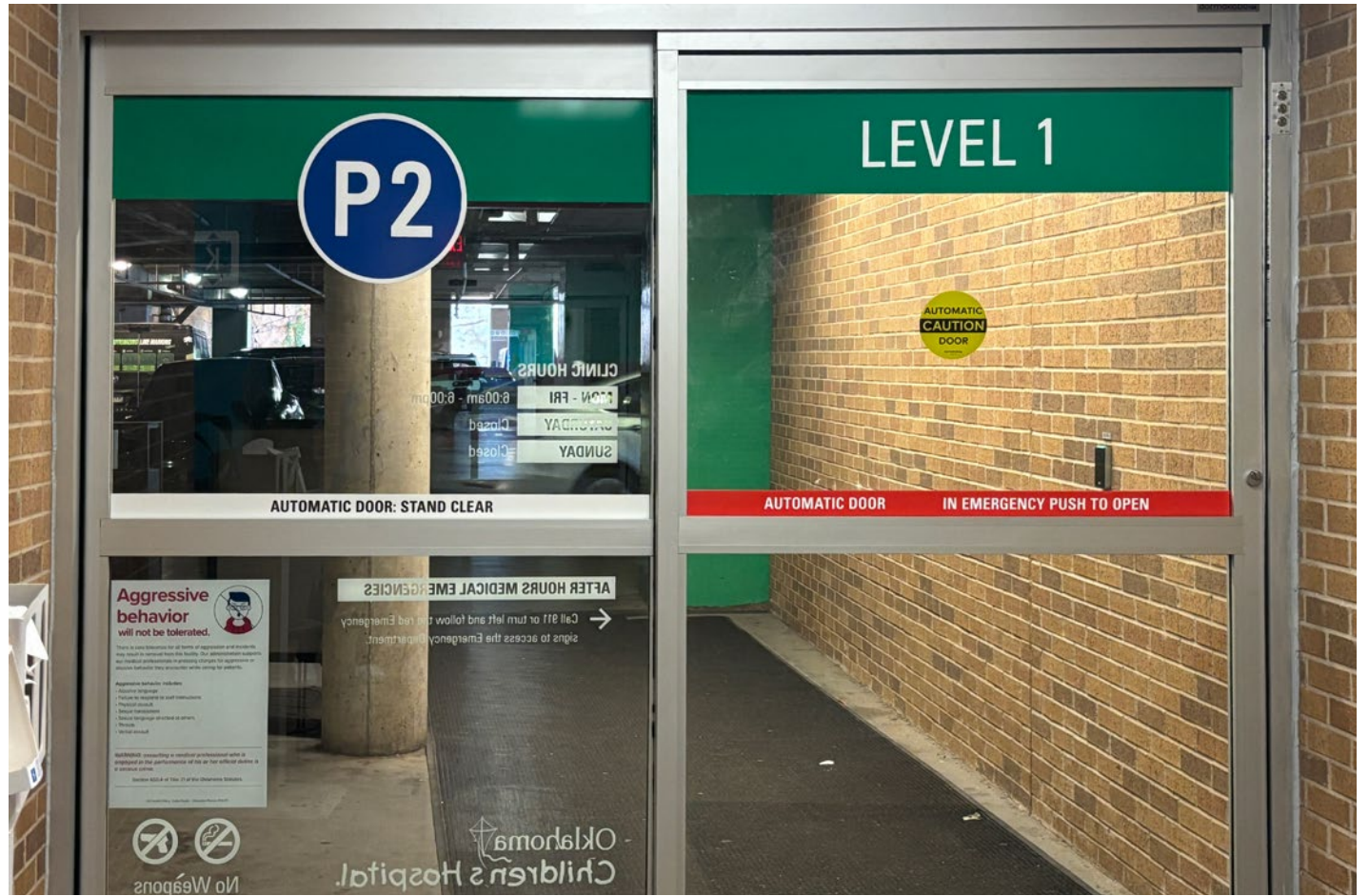

Temporary Signs

Print & Laminate
 Acrylic Stands
 Large Sign Stands
 Snap Frame Stands
 Stanchion w/ Sign Topper



Print & Laminate

Directionals

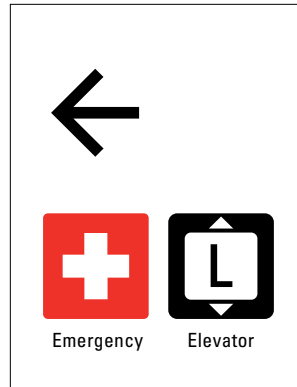

Specialty Messaging

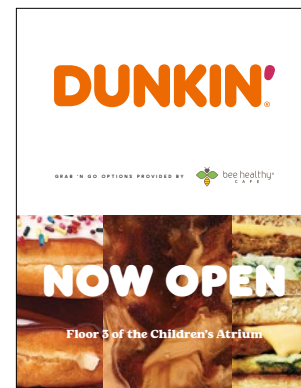
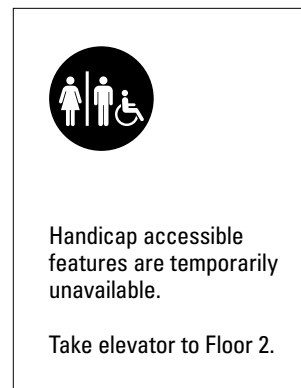
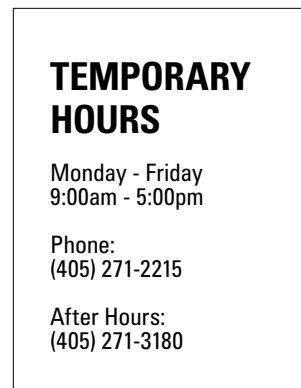
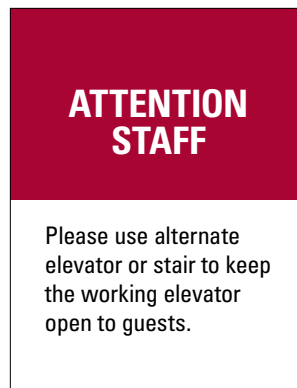

OVERVIEW

A sign can be printed and laminated in the UHAT offices for a variety of uses. A print and laminate sign is typically posted as a temporary message in a public or private space where a permanent sign isn't ideal or might overextend production, install or budget.

MESSAGING

Message suggested by requester and approved or edited by UHAT or department leadership.

SPECS

8.5" x 11"
Laminated Print (UHAT)

INSTALLATION

Painters Tape

Acrylic Stands

Clinic-specific Reception Desk Signs

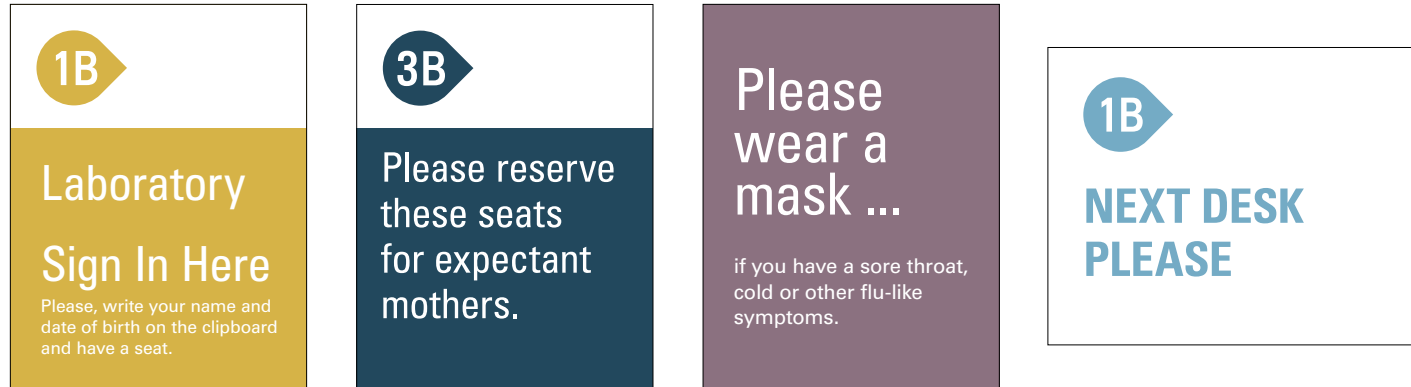

Facility Reception Desk Signs

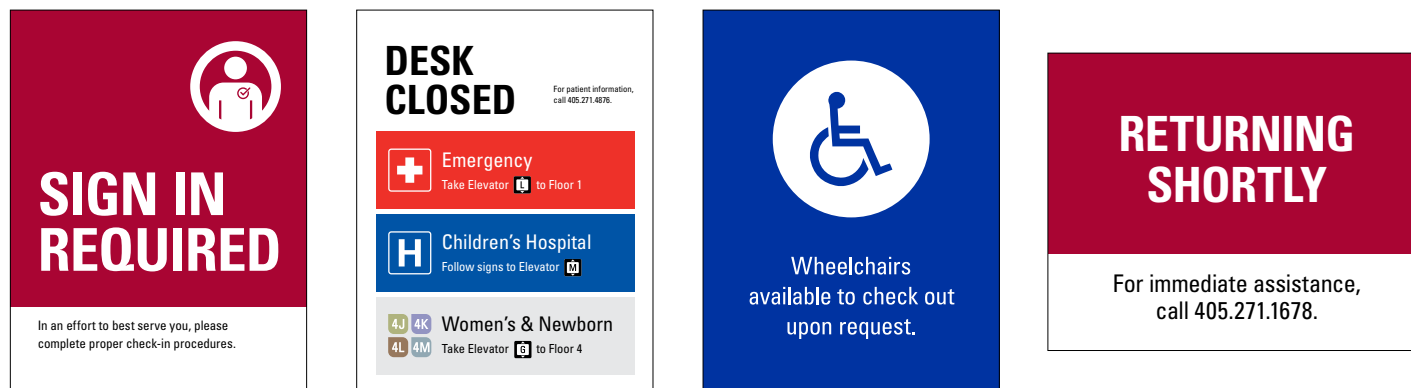

OVERVIEW

Acrylic stands are a good way to display timely info that may change location or relevancy hour-to-hour or day-to-day. Reception desks use this solution the most. They are able to display check-in instructions, location or other reception-specific information.

MESSAGING

Message suggested by requester and approved or edited by UHAT or department leadership.

SPECS

8.5" x 11" (Landscape or Portrait)
8.5" x 5.5" (Landscape or Portrait)

INSTALLATION

Printed insert slides into acrylic stand.

Large Sign Stands



P Elevator		Health Physicians
5	<ul style="list-style-type: none"> Neurology Women's Pelvic & Bladder Health Center Urology 	
PATH To Elevators: A-11, B-11, C-11		
4	<ul style="list-style-type: none"> Allergy Services Ear, Nose & Throat Plastic Surgery General Surgery 	
3	<ul style="list-style-type: none"> Women's Health Breast Institute 	
2	<ul style="list-style-type: none"> Main Entrance / Lobby Parking / Valet Pharmacy Pain Medicine OUP Executive Health Cardiology, Pulmonary & Vascular Medicine Cardiovascular Diagnostics 	
1	<ul style="list-style-type: none"> Laboratory Orthopedic Surgery Radiology Bee Healthy Cafe 	



OVERVIEW

A large rolling sign stand is a great way to draw attention to a temporary sign for a large audience in a large space. This sign can also be positioned in a way to block pedestrian movement or help block off an elevator, restroom, hallway, etc.

SPECS

22" x 28"
24" x 36"

INSTALLATION

Printed insert on a rigid substrate like PVC or foam board.

MESSAGING

Message suggested by requester and approved or edited by UHAT or department leadership.

Snap Frame Stands



OVERVIEW

Sign Stands are a great way to draw attention to a temporary sign and sometimes a permanent message. Sign Stands can be placed in strategic positions that increase the chance that staff or guests will see the sign. This positioning can also double as a barricade to help block off an elevator, restroom, hallway, etc.

MESSAGING

Message suggested by requester and approved or edited by UHAT or department leadership.

SPECS

- 8.5" x 11" (Landscape or Portrait)
- 11" x 17" (Landscape or Portrait)

INSTALLATION

Printed insert placed inside sign stand.

Stanchion w/ Sign Topper



OVERVIEW

Stanchions with retractable belts are typically used to corral guests to form a line or temporarily block access to an area. These stanchions can also support a sign topper that provides an opportunity to include a helpful message.

MESSAGING

Message suggested by requester and approved or edited by UHAT or department leadership.

SPECS

8.5" x 11" (Landscape or Portrait)
11" x 17" (Landscape or Portrait)

INSTALLATION

Printed insert placed inside topper of stanchion.

Donor Signs

- Room Sign Topper
- Room Sign Topper (OCH)
- Room Donor (w/o Room Sign)
- Donor Story Panel
- Dimensional Lettering
- Building Donor Wall
- Exterior Sculpture Plaque
- Exterior Dimensional Lettering
- Exterior Donor Space



Room Sign Topper



OVERVIEW

In Garrison Tower, Ronald McDonald House chooses to identify the donors that help make their service possible. This is accomplished by labeling each room with the donor name. These signs are made from similar materials and at the same with as the standard facility room sign STD.1.

MESSAGING

Provided by tenant.

SPECS

.25" Back-printed Acrylic
5.25" x 5.25"

INSTALLATION

Painters Tape
1" above STD.1

EXAMPLES OF DONOR SIGNS IN RONALD MCDONALD HOUSE



SW9149 Inky Blue



SW6881 Cayenne

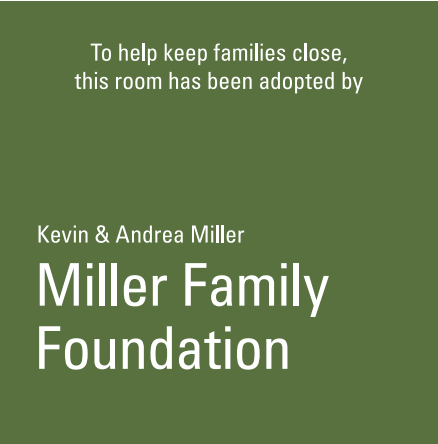

SW6727 Houseplant

Room Sign Topper (OCH)

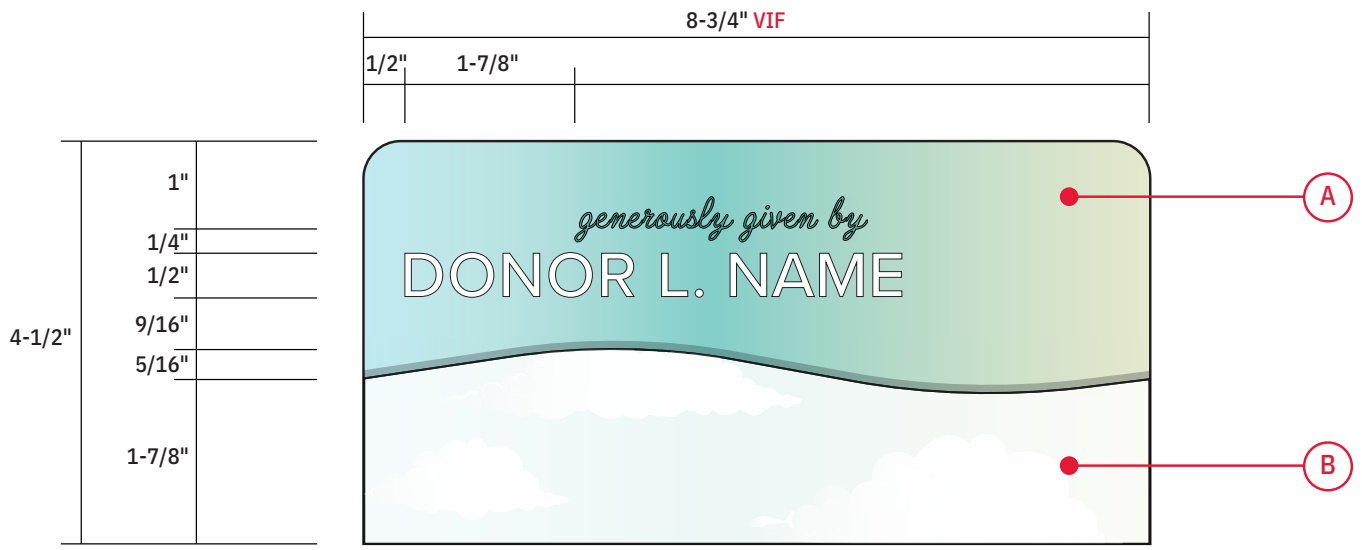

1 DN-01A Room Sign Small
 Front Elevation
 Scale: 6" = 1'-0"

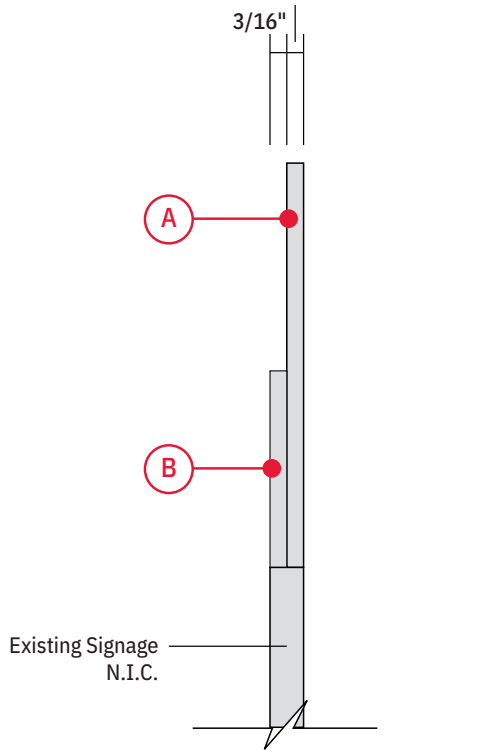

2 DN-01A Room Sign Small
 Section View

Small

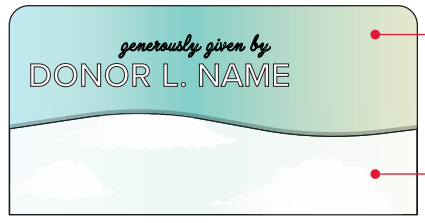

Medium

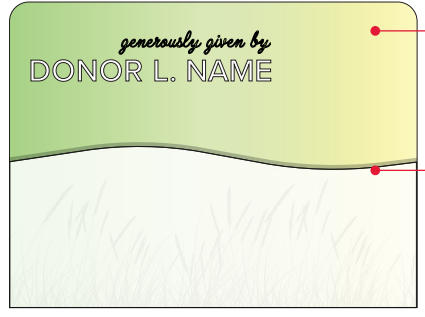

Large

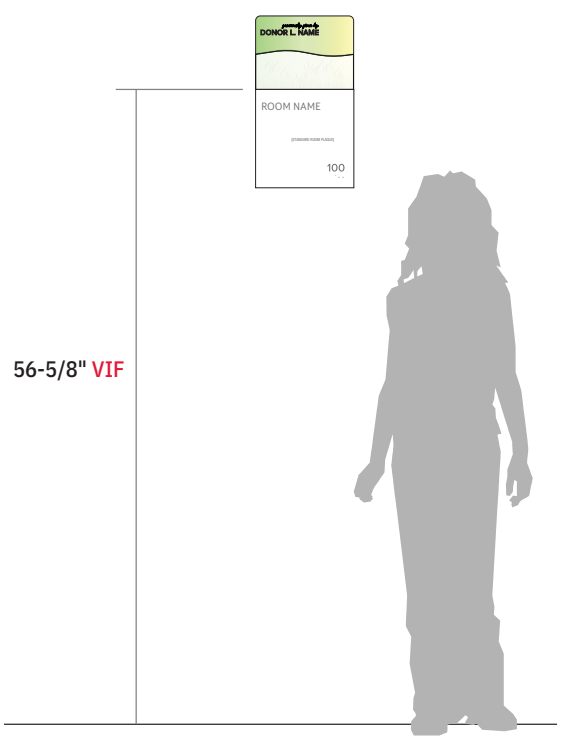
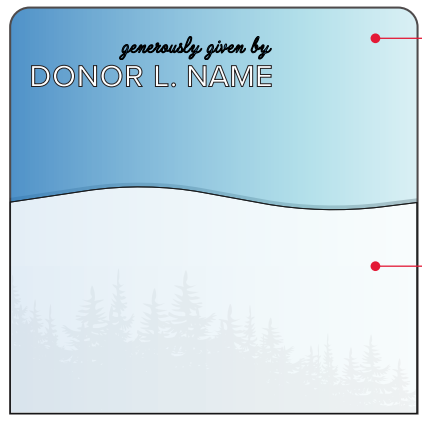

Room Donor (w/o Room Sign)

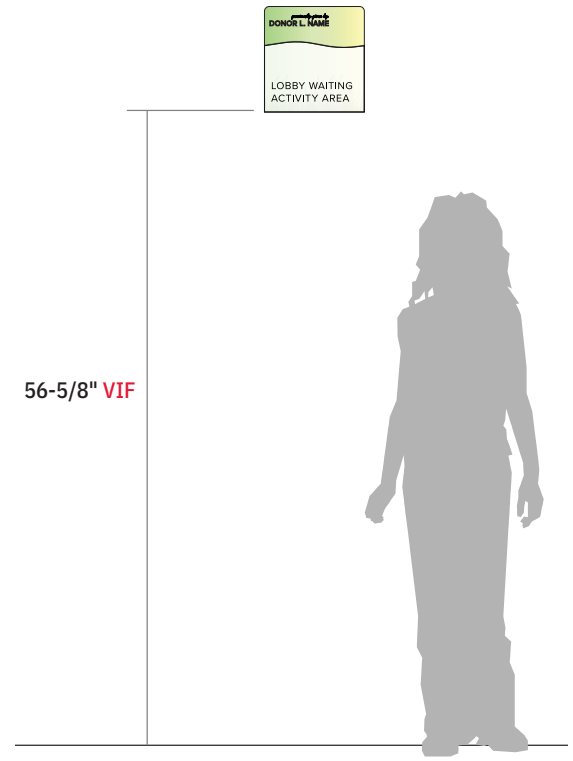
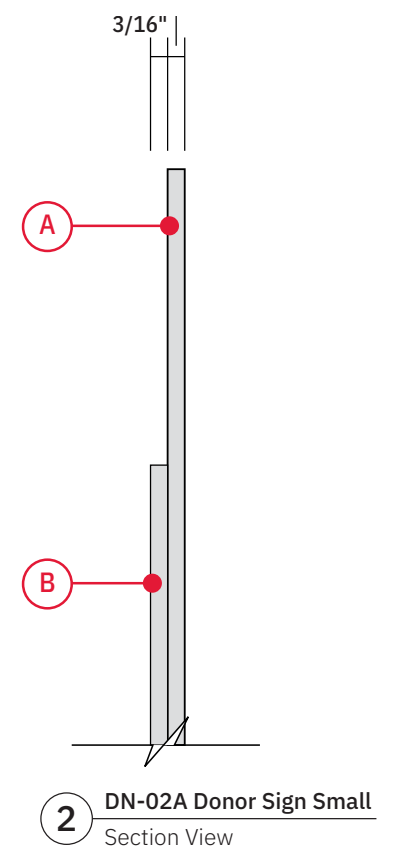
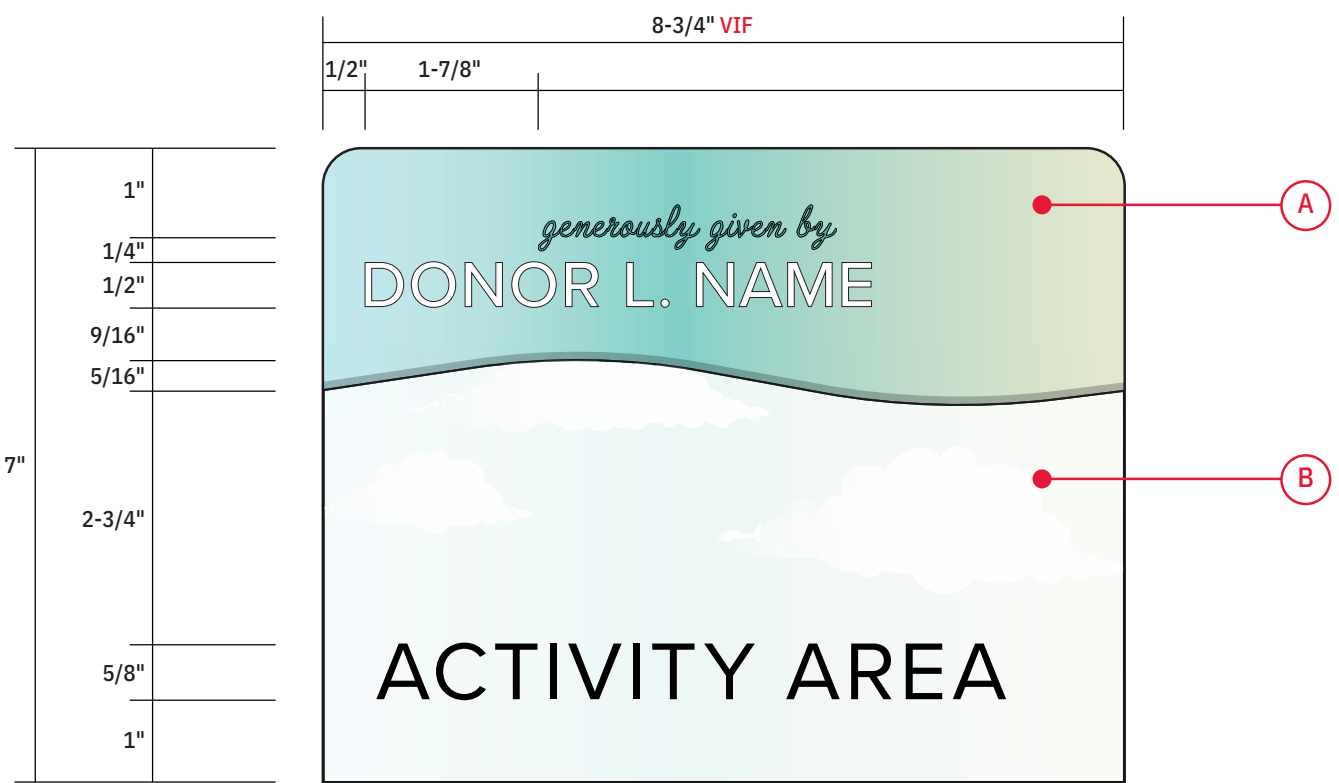

Small



Medium

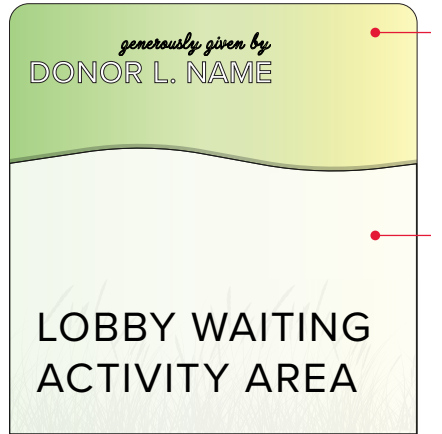

Large

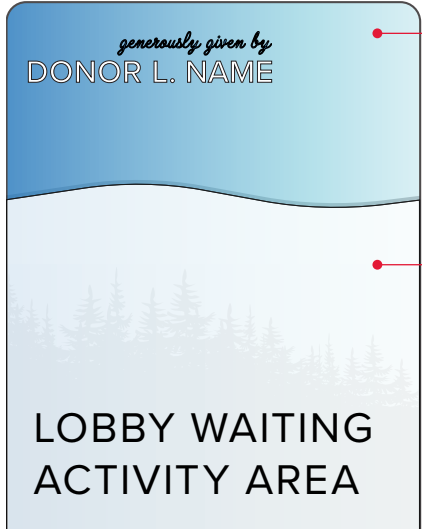

Donor Story Panel

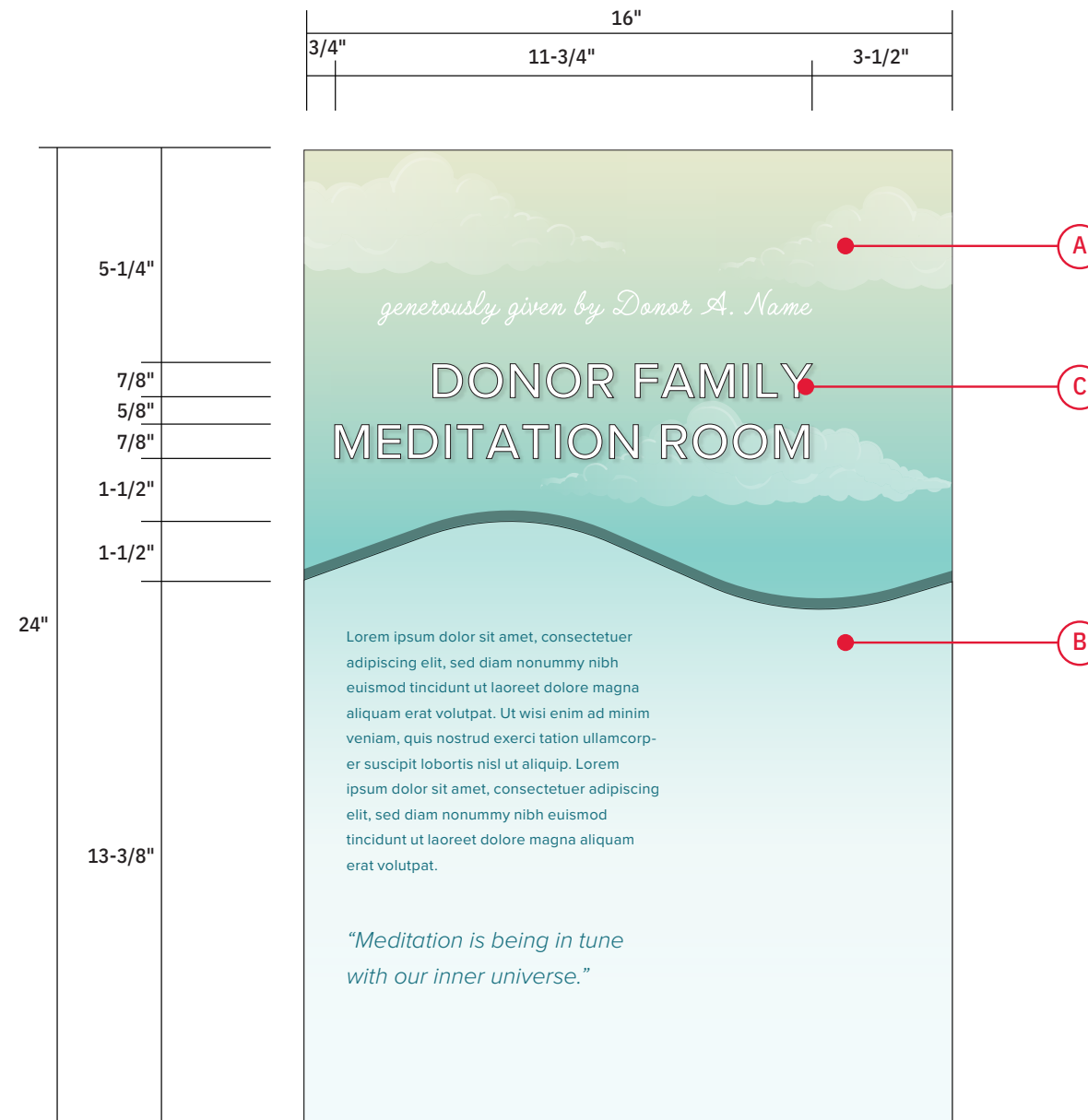

1 DN-03 Donor Story Panel
Front Elevation
Scale: 3" = 1'-0"

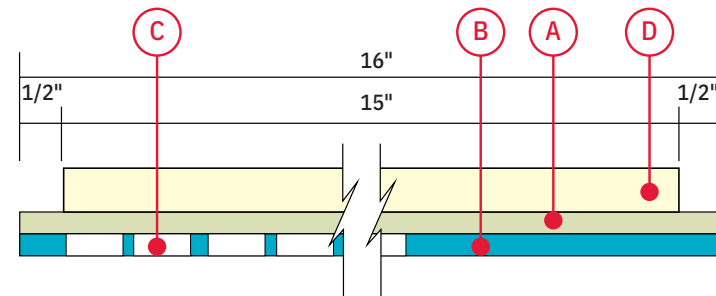

2 DN-03 Donor Story Panel
Plan View
Scale: 6" = 1'-0"

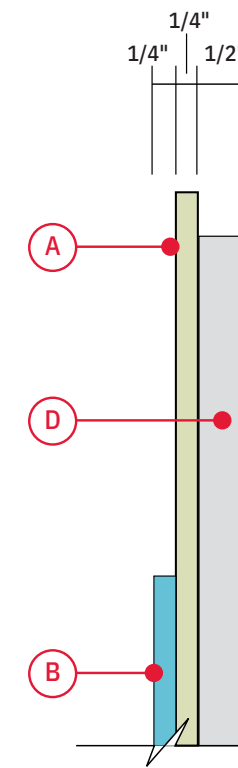

2 DN-03 Donor Story Panel
Section View
Scale: 6" = 1'-0"

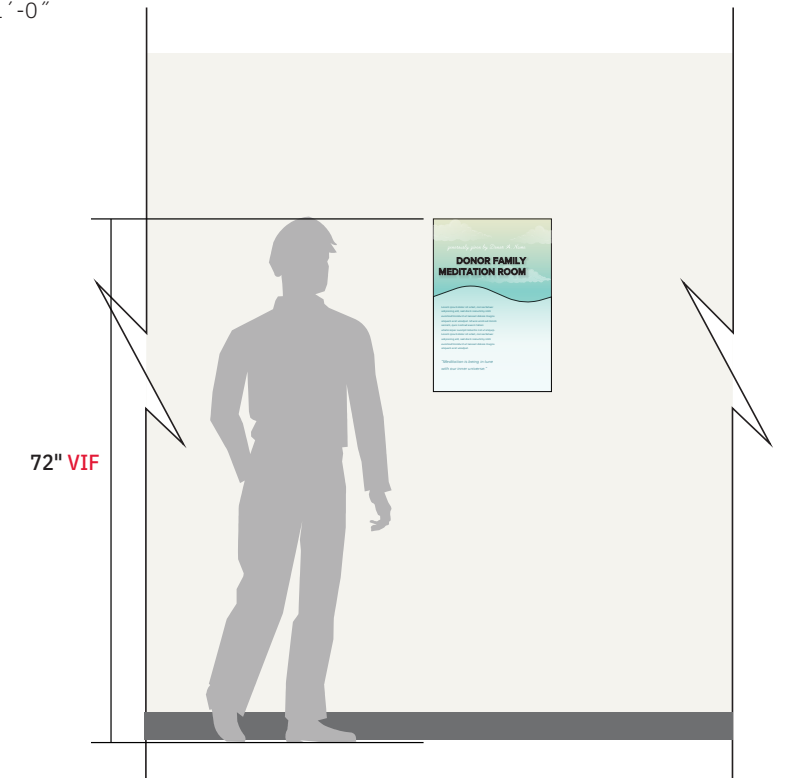

3 DN-03 Donor Story Panel
Mounting Elevation
Scale: 1/2" = 1'-0"

Dimensional Lettering



Small

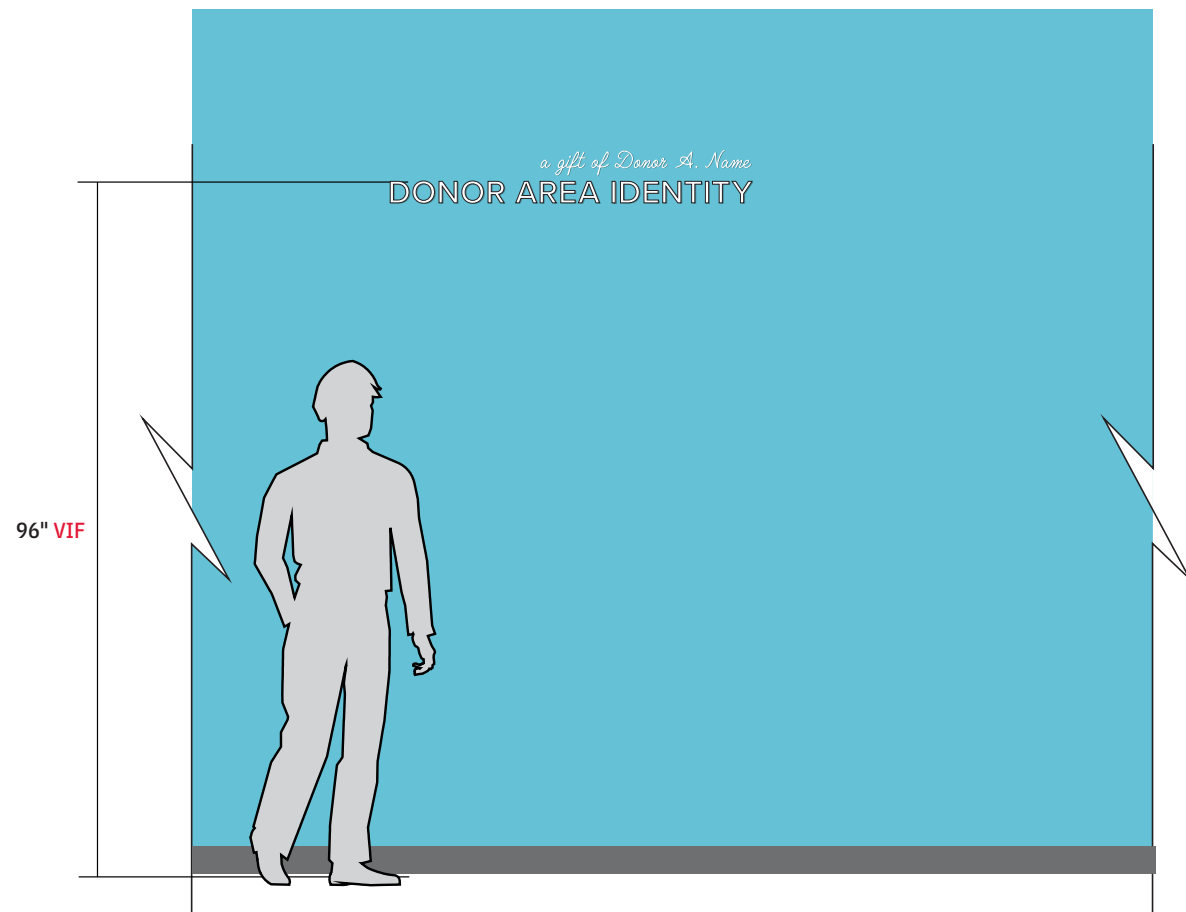

Large

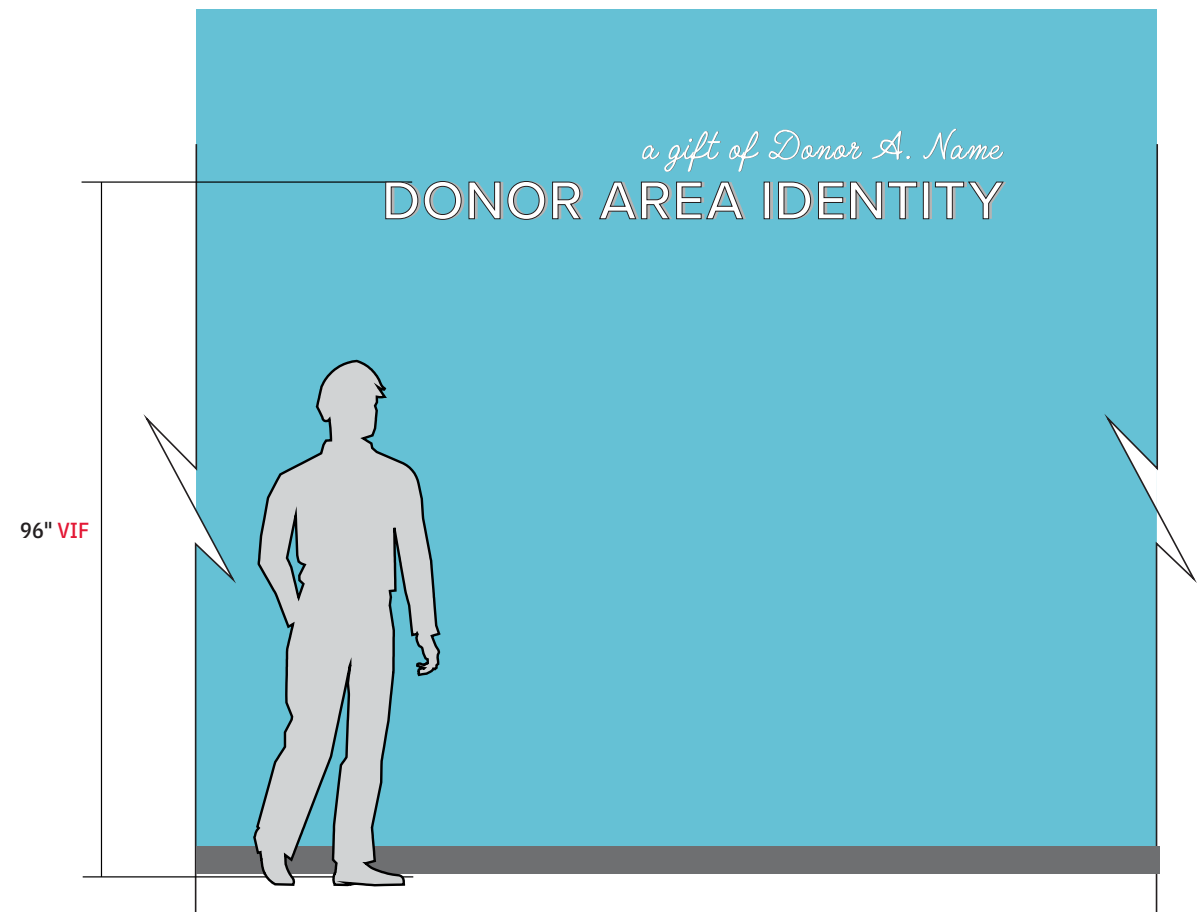

Building Donor Wall

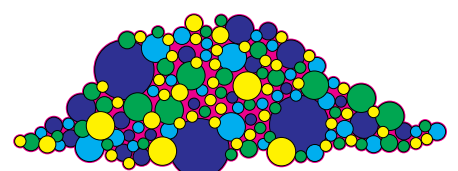
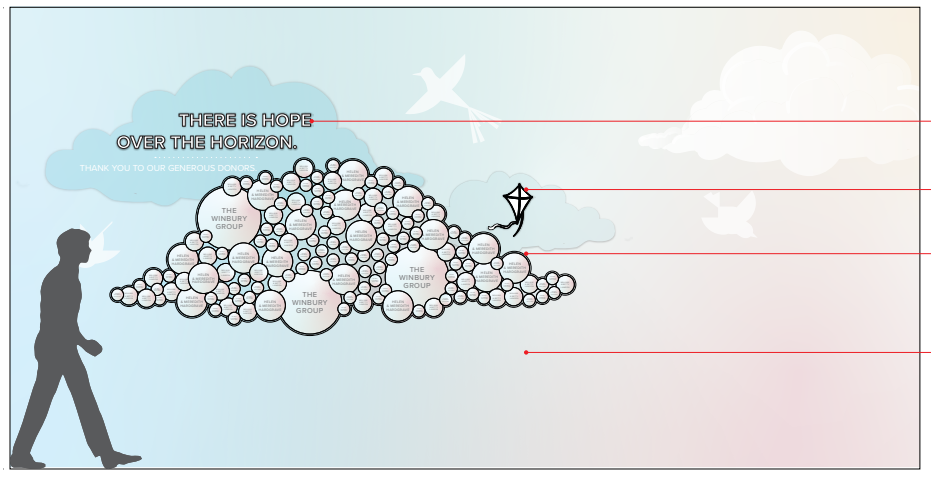
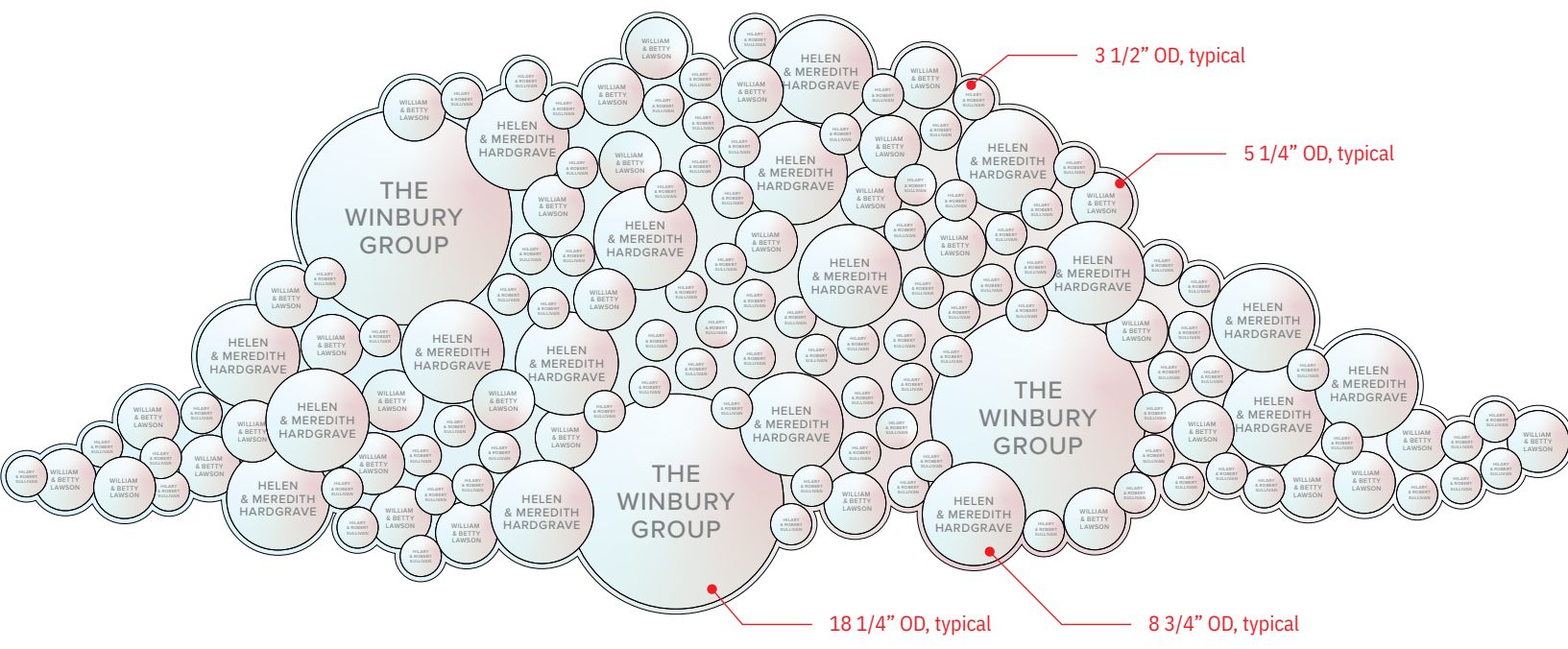

BUILT WALL - FOR REPRESENTATION PURPOSES ONLY

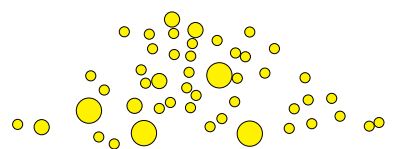

LEVEL 1 - 1" THK. ACRYLIC

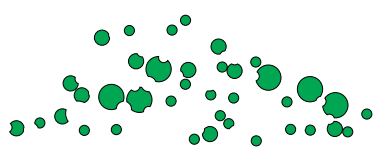

LEVEL 1 - 3/4" THK. ACRYLIC

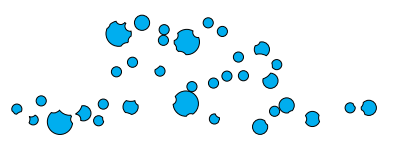

LEVEL 1 - 1/2" THK. ACRYLIC

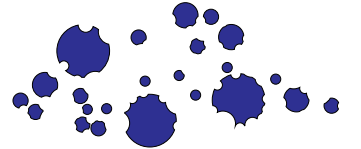

LEVEL 1 - 1/4" THK. ACRYLIC



LEVEL 1 - 1/2" THK. MDF (mechanically fastened with concealed hardware)

Exterior Sculpture Plaque

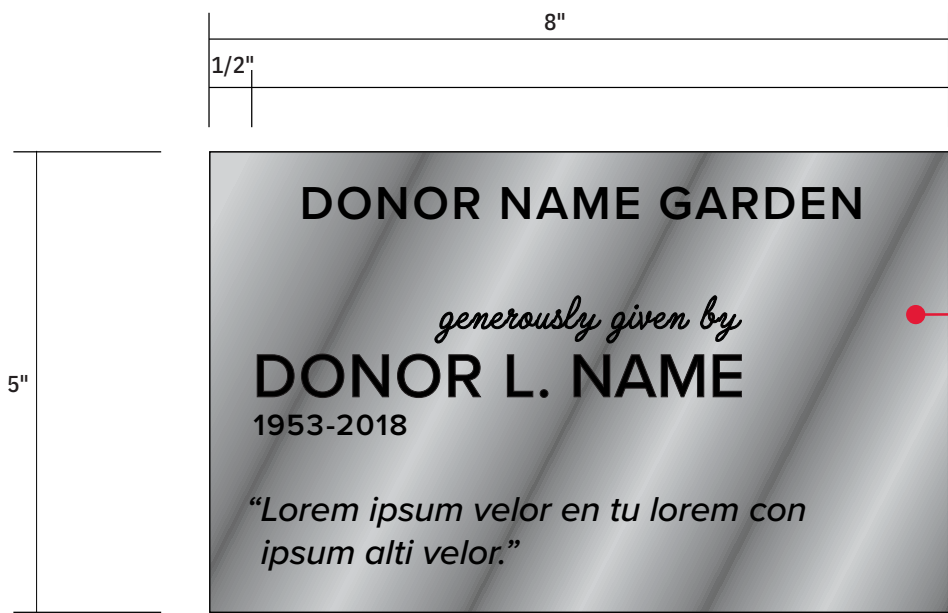

1 DN-07 Sculpture Donor Plaque
 Front Elevation
 Scale: 6" = 1'-0"

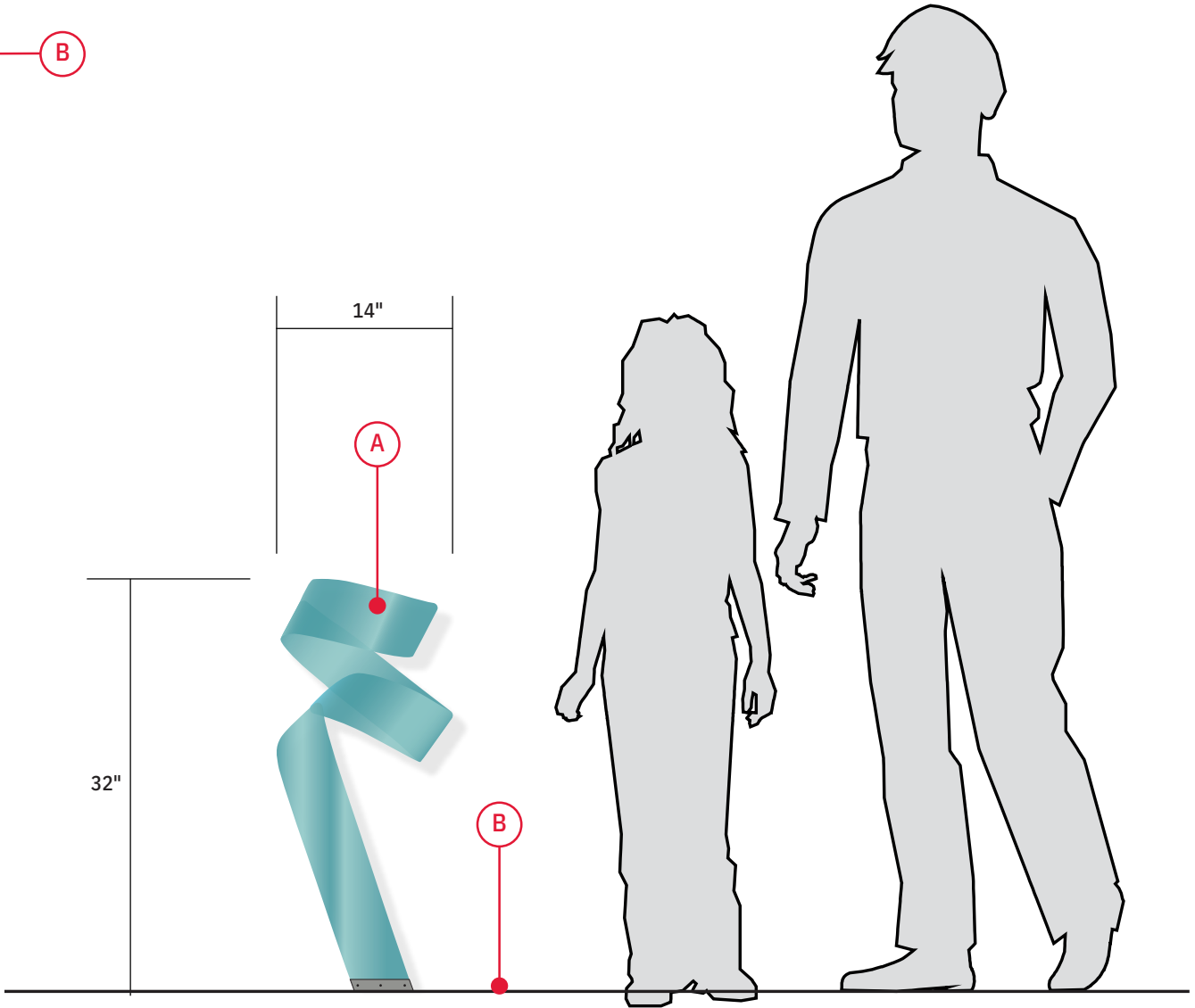

2 DN-07 Sculpture
 Mounting Elevation
 Scale: 1" = 1'-0"

Exterior Dimensional Lettering



1 DN-08 Dimensional Letters, Exterior
 Front Elevation
 Scale: 3/4" = 1'-0"

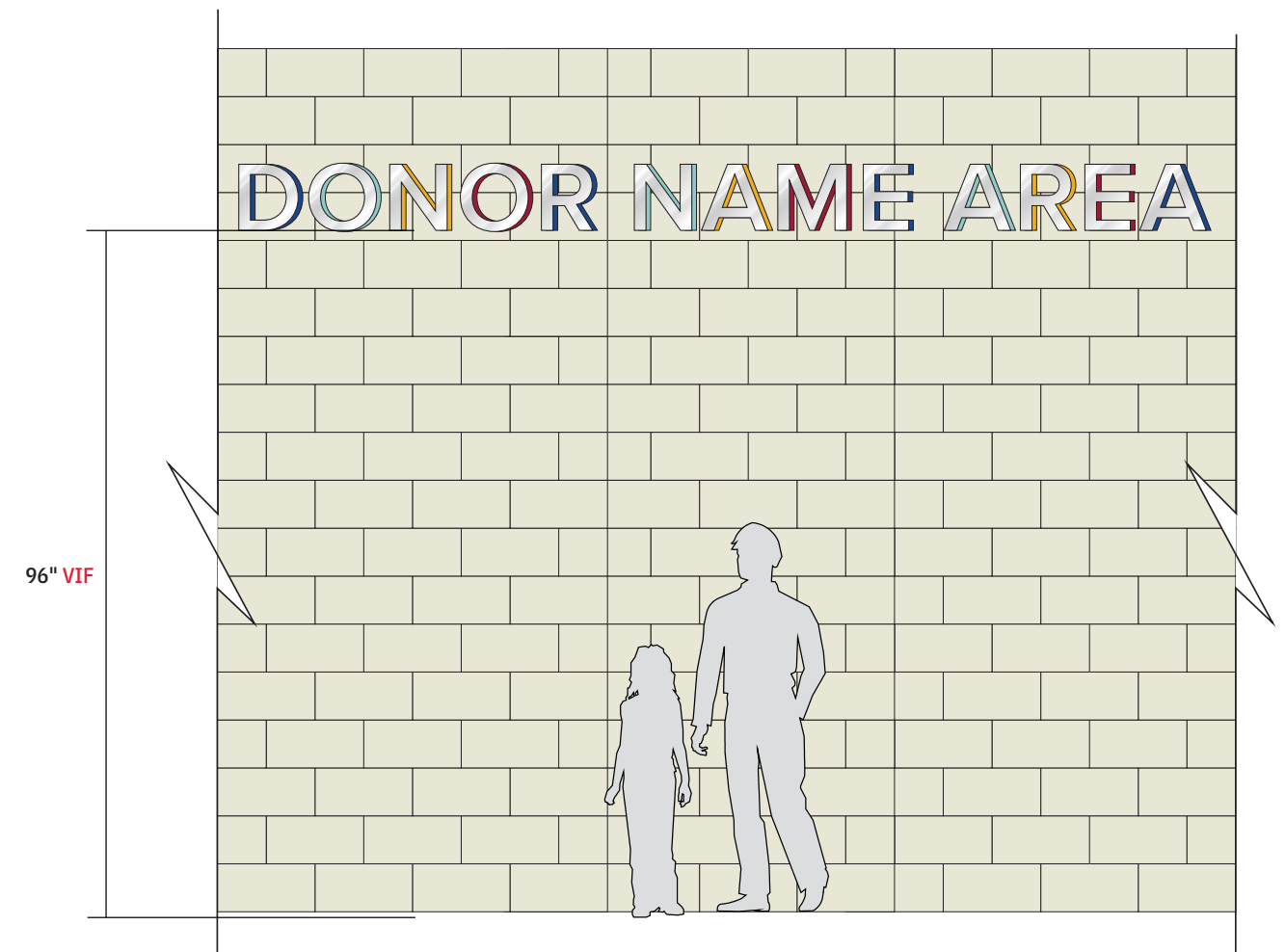

2 DN-08 Dimensional Letters, Exterior
 Mounting Elevation
 Scale: 3/8" = 1'-0"

Exterior Donor Space



1 DN-09 Exterior Donor Sign
 Front Elevation
 Scale: 3" = 1'-0"

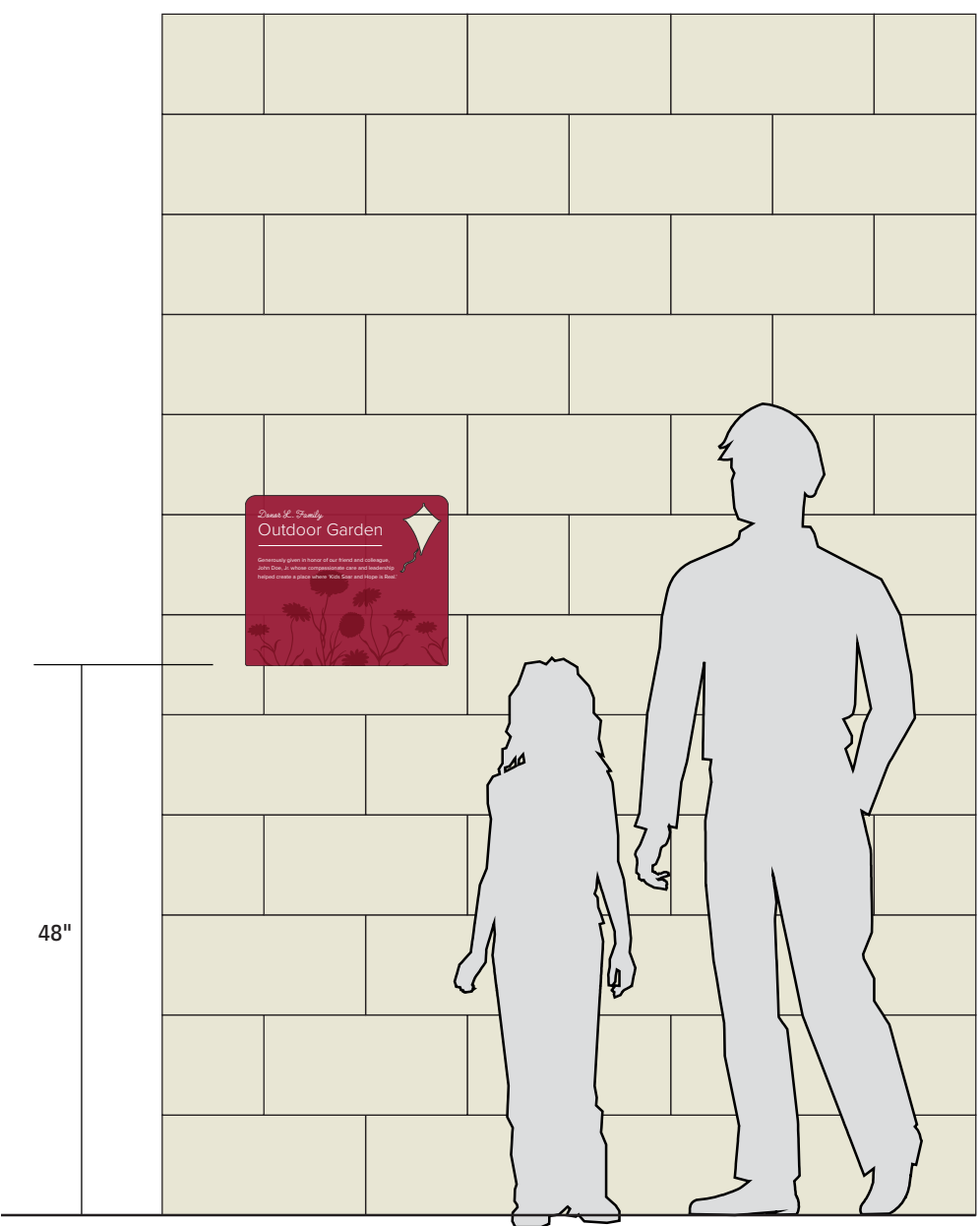

2 DN-09 Exterior Donor Sign
 Mounting Elevation
 Scale: 3/4" = 1'-0"

Parking & Valet

Valet Podium Magnets
Trailblazer
Water-base Sign Holder
Reserved Parking
Roll 'n Pole
No Smoking Stakes



Valet Podium Magnets

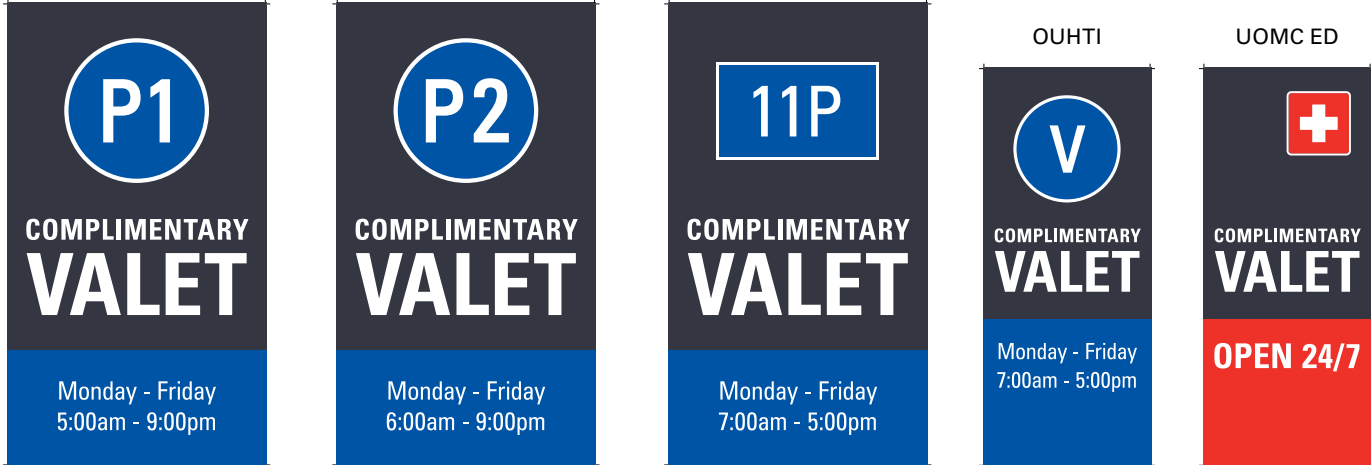

EXAMPLES OF LARGE MAGNETS IN USE



SMALLER MAGNETS

OVERVIEW

Printed magnets for metal valet podium to communicate parking location and hours.

SPECS

- 15.5" x 37"
- 24" x 43"

MESSAGING

Message suggested by requester and approved or edited by UHAT or department leadership.

INSTALLATION

Place magnet on face of podium.

Trailblazer

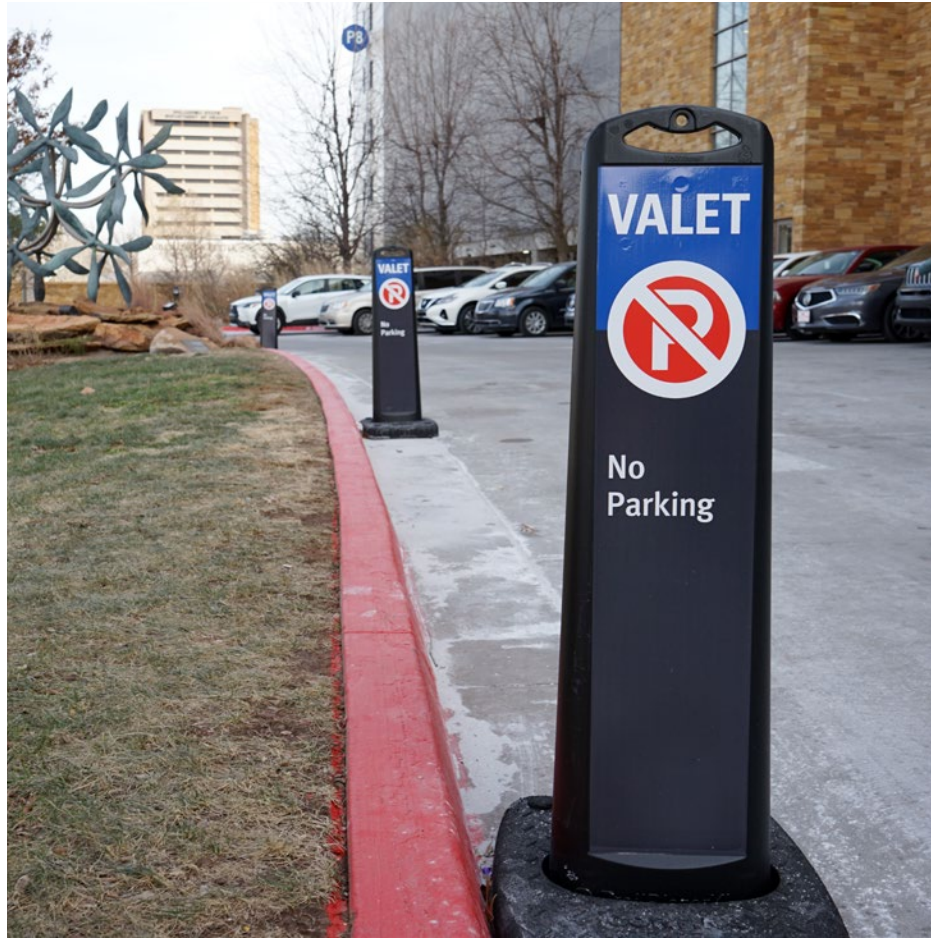
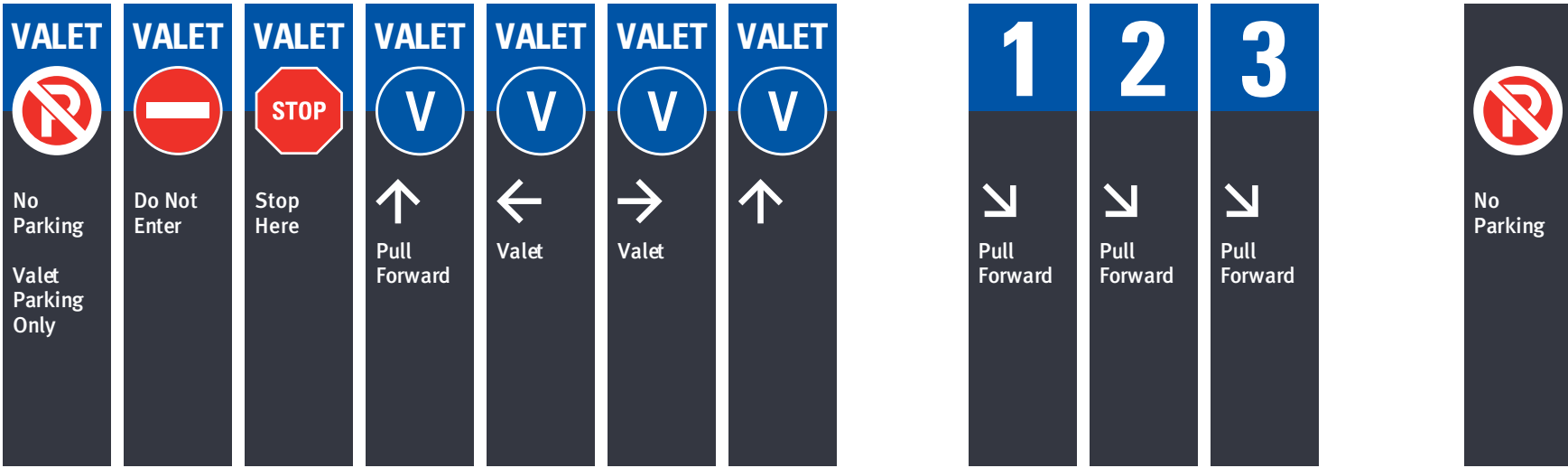

OVERVIEW
 A black plastic "cone" with a weighted rubber base for directing motorists around a facility, parking or valet entrance.

VINYL IMPRINT AREA
 8.25" x 36"

MESSAGING
 Message suggested by requester and approved or edited by UHAT or department leadership.

INSTALLATION
 Vinyl print applied to plastic Trailblazer.

Water-base Sign Holder

<p>V</p> <p>AFTER-HOURS VALET</p> <p>(405) 271-2255</p> <p><small>Call for After-Hours vehicle retrieval valet service. Retrieval may take up to 30 minutes.</small></p>	<p>P1</p> <p>AFTER-HOURS VALET</p> <p>(405) 271-2255</p> <p><small>Call for After-Hours vehicle retrieval valet service. Retrieval may take up to 30 minutes.</small></p>	<p>11P</p> <p>AFTER-HOURS VALET</p> <p>(405) 271-2255</p> <p><small>Call for After-Hours vehicle retrieval valet service. Retrieval may take up to 30 minutes.</small></p>	<p>NICHOLSON</p> <p>AFTER-HOURS VALET</p> <p>(405) 271-2255</p> <p><small>Call for After-Hours vehicle retrieval valet service. Retrieval may take up to 30 minutes.</small></p>
---	--	---	---



EXAMPLES OF INSERTS USED AT VALET

OVERVIEW

This black plastic sign frame on a base weighted with water is good for both permanent or temporary messaging in exterior spaces like sidewalks, parking lots, entrances or other special locations to help direct motorists or pedestrians with simple messaging.

SPECS

24" x 36"
Printed on outdoor substrate

MESSAGING

Message suggested by requester and approved or edited by UHAT or department leadership.

Reserved Parking

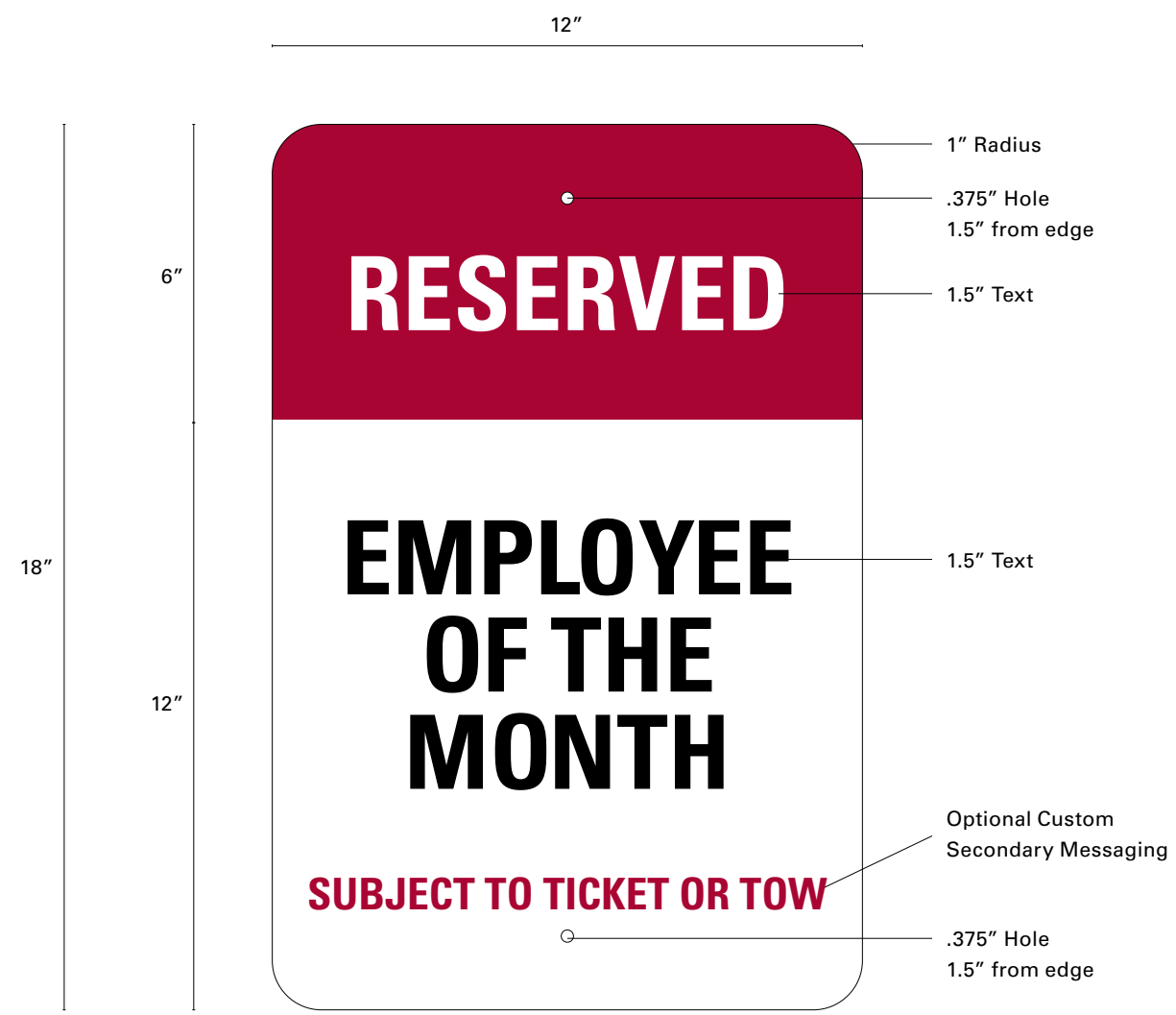

EXAMPLES OF SIGNS IN GARAGE P2 & AROUND CHILDREN'S

RESERVED AIR EVAC TEAM PARKING ONLY	RESERVED CATERING PARKING ONLY	RESERVED LAB COURIER ONLY <small>SUBJECT TO TICKET OR TOW</small>	RESERVED LAB PARKING ONLY	RESERVED HEART CENTER TRANSPORT	RESERVED CRITICAL CARE TRANSPORT	RESERVED EXPECTANT MOTHERS
RESERVED FACULTY PHYSICIAN PARKING <small>TOW-AWAY ZONE VIOLATORS WILL BE TOWED AT TOWNER'S EXPENSE</small>	RESERVED ANESTHESIA CALL PHYSICIAN	RESERVED CHILDREN'S HOSPITAL VOLUNTEER	RESERVED DROP-OFF & PICK-UP ONLY	RESERVED RESIDENT OF THE MONTH <small>SUBJECT TO TICKET OR TOW</small>	RESERVED POLICE ONLY <small>TOW-AWAY ZONE VIOLATORS WILL BE TOWED AT TOWNER'S EXPENSE</small>	RESERVED DELIVERIES ONLY
RESERVED DIALYSIS PATIENT ONLY <small>SUBJECT TO TICKET OR TOW</small>	RESERVED EXECUTIVE GUESTS <small>SUBJECT TO TICKET OR TOW</small>	RESERVED EMPLOYEE OF THE MONTH <small>SUBJECT TO TICKET OR TOW</small>	RESERVED EMERGENCY PHYSICIAN ONLY <small>SUBJECT TO TICKET OR TOW</small>	RESERVED SUPERSTAR PARKING YOU MAKE A DIFFERENCE!	RESERVED BIKE STORAGE ONLY <small>PLEASE CALL PARKING SERVICES FOR RESERVATIONS 405-271-7032</small>	RESERVED DONATION DROP-OFF ONLY <small>OklahomaChildrens.org/Giving (405) 821-6517</small>

OVERVIEW

A typical parking sign with custom messaging to reserve parking spots in garages and lots across OHC campus.

PRODUCT SPECS

12" x 18"

MESSAGING

Message suggested by requester and approved or edited by UHAT or department leadership.

INSTALLATION

Signs come with two holes for installation with preferred or provided bolts on new or existing poles or wall. Holes are optional.

Roll 'n Pole



OVERVIEW

A 4 ft. pole on a weighted base with wheels is best suited as a temporary sign for parking spots.

PRINT SPECS

Fits various sign dimensions.

MESSAGING

Message suggested by requester and approved or edited by UHAT or department leadership.

No Smoking Stakes

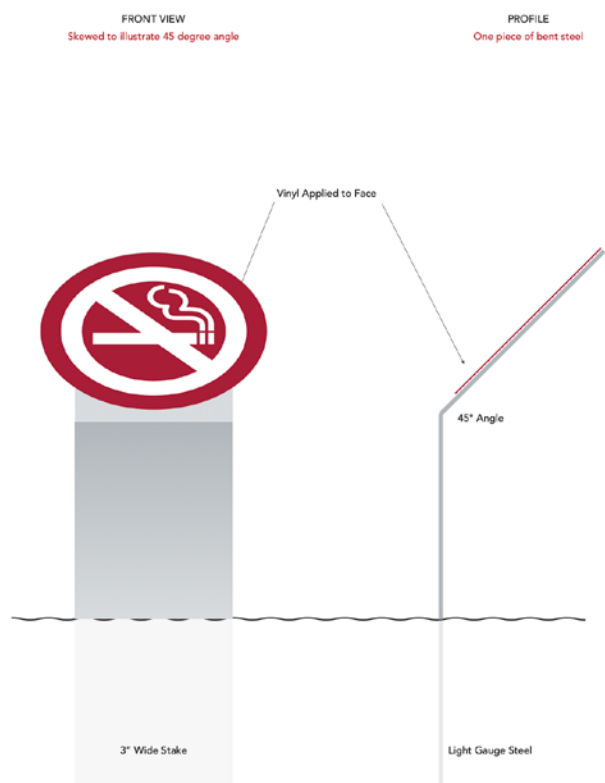

OVERVIEW

4" vinyl print mounted on angled stake.

PRINT SPECS

Fits various sign dimensions.

MESSAGING

White No Smoking symbol on OU Crimson colored disc.

HOW TO GIVE PROPER DIRECTIONS

CAMPUS WAYFINDING OVERVIEW

As the Oklahoma Health Center changes and grows, we need a wayfinding system that can grow with us. Patients and visitors have high expectations about the quality of care they receive. Their ability to easily find their way around our buildings directly impacts their perception of the care that Oklahoma Health Center provides. An effective wayfinding system is a key ingredient to creating a positive visitor experience.

An important part of this system is for all Oklahoma Health Center employees and volunteers to speak the language of the wayfinding system. This document will introduce important locations, symbols and verbiage to help you efficiently and consistently direct visitors.

DRIVING DIRECTIONS TO OKLAHOMA HEALTH CENTER



- Direct visitors to their destination using the 4 Simple Steps.



" Turn onto **13TH** Street
 Park at **P2**
 Take Elevator **K** to Floor 4
 Follow signs to **4B** "

WALKING DIRECTIONS ON CAMPUS PATH

- Direct visitors inside buildings to look for elevators nearest the final destination.
- If the desired elevator is in another building, direct visitors to the PATH that connects the buildings.

" Follow the **PATH** to Elevator **K** "

Elevator symbols are visible on overhead signs and maps along the PATH and in elevator lobbies.

Parking Guests



Parking structures for guests are identified by blue symbols like this one.

The universal parking color & letter "P" coupled with an organized numeric system helps guests find parking more quickly.

Landmarks Guests

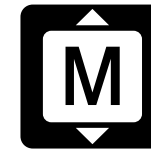

Elevators are very important landmarks on campus. Directing guests to the correct elevator is key to locating final destinations.

Elevators A thru W are organized along the PATH from West to East.

Destination Clinics



"Teardrop" symbols identify destinations in clinic spaces, like OU Health Physicians and Oklahoma Children's Hospital Clinics.

The alpha-numeric designation defines floor number and the clinic position on that floor.

Destination Hospital



These square symbols identify destinations in hospital spaces, like University of Oklahoma Medical Center & Oklahoma Children's Hospital.

The alpha-numeric designation defines floor number and the department position.

PATH



PATH is the symbol for the public indoor walkway system that connects major destinations within the Oklahoma Health Center campus. PATH will be easy to navigate by following this symbol through every turn.

The color of PATH is intentionally unique to the campus, so that it stands out as you make your way through different facilities.

